

2026
Preview Collection



**cattelan
italia**



Indice / Index

Tavoli

Tables

- 8 *Bilbao Glass*
- 39 *Giano Marble*
- 14 *Gotham Keramik Drive*
- 44 *Napoleon Keramik Outdoor*
- 38 *Papel Marble*
- 43 *Rado Keramik Round Outdoor*
- 20 *Senator Keramik Magnum*
- 32 *Skorpio Marble*
- 42 *Skorpio Marble Round*
- 36 *Tyron Marble*
- 40 *Yoda Marble*

Sedie

Chairs

- 62 *Britney Turn*
- 56 *Charlotte*
- 52 *Giselle*
- 68 *Greta Outdoor*
- 66 *Greta Wood*
- 58 *Magda Barrè*
- 60 *Magda ML Barrè*

Sgabelli

Stools

- 70 *Magda Barrè*
- 71 *Magda ML Barrè*

Scrivanie

Desks

- 48 *Boston*

Divani

Sofas

- 72 *Baldwin*
- 84 *Gibson*
- 96 *Murphy*

Poltrone

Armchairs

- 110 *Baldwin Turn*
- 102 *Margaret*
- 106 *Peggy Turn*

Sedie Lounge

Lounge Chairs

- 112 *Giselle Lounge*

Pouf

Poufs

- 114 *Sierra Pouf*

Tavolini

Coffee Tables

- 132 *Amalfi*
- 128 *Bishop*
- 124 *Lagoon*
- 116 *Matera*
- 120 *Standard*

Consolle

Consoles

- 140 *Brio Keramik*
- 138 *Peninsula*

Lampade

Lamps

- 158 *Potter*
- 150 *San Marco*
- 154 *Wanted*

Librerie

Bookcases

- 146 *Address*

Specchi

Mirrors

- 160 *Pierre*

Letti

Beds

- 162 *Richard*

Comodini

Nightstands

- 166 *Elias*

Madie

Sideboards

- 142 *Chelsea*
- 144 *Chelsea Drawers*

Complementi

Complements

- 136 *Felix*
- 168 *Kiran*

Nuove Finiture

New Finishes

- 172

2026 Collection

Tavoli

Tables



Bilbao Glass

8



Giano Marble

39



Gotham Keramik Drive

14



Napoleon Keramik Outdoor

44



Papel Marble

38



Rado Keramik Round Outdoor

43



Senator Keramik Magnum

20



Skorpio Marble

32



Skorpio Marble Round

42



Tyron Marble

36



Yoda Marble

40

Scrivanie

Desks



Boston

48



Britney Turn

62



Charlotte

56



Giselle

52



Greta Outdoor

68



Greta Wood

66



Magda Barrè

58



Magda ML Barrè

60

Sedie

Chairs

2026 Collection

Sgabelli

Stools



Magda Barrè Sgabello

70



Magda ML Barrè Sgabello

71

Divani

Sofas



Baldwin

72



Gibson

84



Murphy

96

Poltrone

Armchairs



Baldwin Turn

110



Margaret

102



Peggy Turn

106

Sedie Lounge

Lounge Chairs



Giselle Lounge

112

Pouf

Pouf



Sierra Pouf

114

Tavolini

Coffee Tables



Amalfi

132



Bishop

128



Lagoon

124



Matera

116



Standard

120

Consolle

Consoles



Brio Keramik

140



Peninsula

138

2026 Collection

Madie

Sideboards



Chelsea Drawers

114

Comodini

Nightstands



Elias

166

Lampade

Lamps



Potter

158



San Marco

150

Complementi

Complements



Felix

136



Kiran

168

Librerie

Bookcases



Address

146

Specchi

Mirrors



Pierre

160

Ampliamenti di gamma / Range extension

Letti

Beds



Richard

162

Madie

Sideboards



Chelsea

142

Lampade

Lamps



Wanted

154

Bilbao Glass

Design: Tosca Design

Tavolo con base in cemento e struttura in acciaio verniciato goffrato titanio, bronzo o nero, Oxybrass o Oxygrey. Piano in cristallo 15 mm trasparente, trasparente extrachiaro, trasparente extrachiaro con bordi bisellati, trasparente extrachiaro con bordi bisellati inversi o extrachiaro cotto. Piano in appoggio.

Table with base in cement and frame in embossed titanium, bronze or black lacquered steel, Oxybrass or Oxygrey lacquered steel. Top in 15mm clear, extra clear, extra clear bevelled glass, extra clear with reversed bevelled edges or extra clear textured glass. The top is laid on the base.

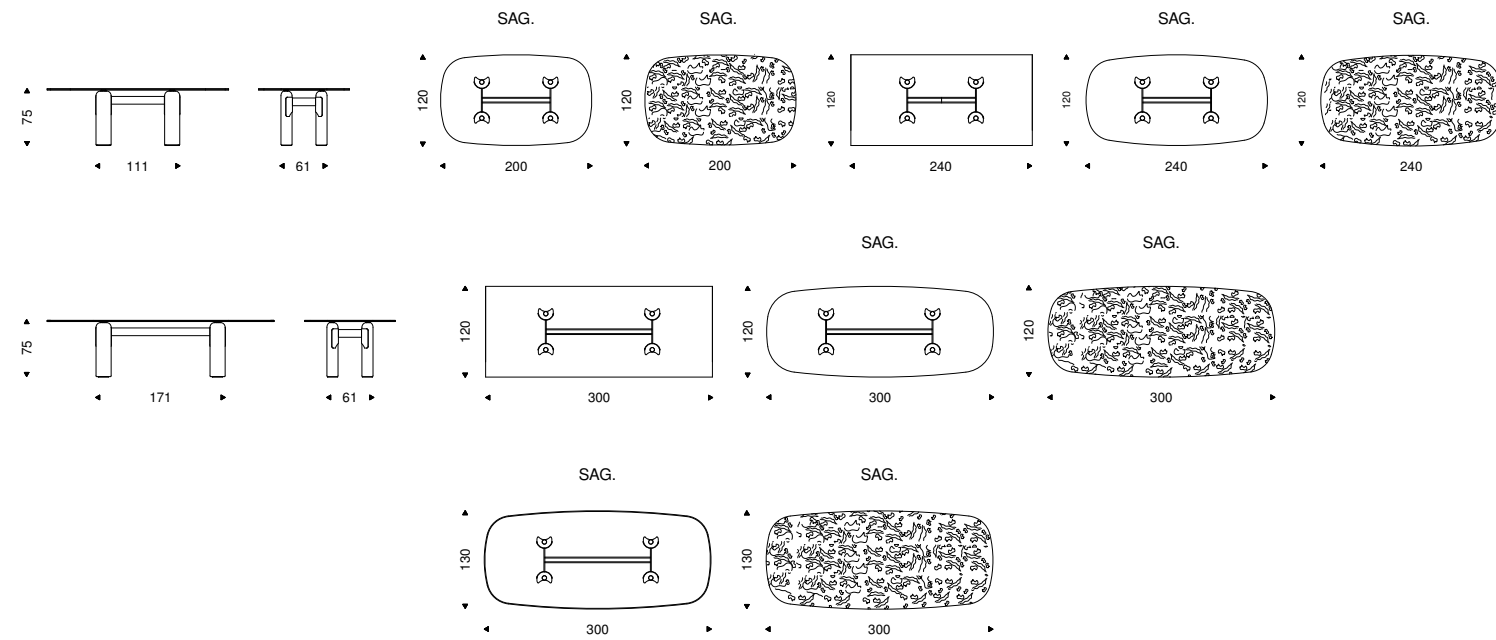

BILBAO GLASS table with cement base, embossed black frame and extra clear bevelled glass top



BILBAO GLASS table with cement base, Oxybrass frame and extra clear bevelled glass top - GISELLE chairs in fabric T30 D108 and burned oak frame - KIRAN rug oval. in Tortora colour PARIS ceiling lamps - FULHAM bookcases in embossed titanium



BILBAO GLASS table with cement base, Oxybrass frame and extra clear bevelled glass top - GISELLE chairs in T30 D108 and burned oak frame - KIRAN rug oval, in Tortora colour
PARIS ceiling lamps - FULHAM bookcases in embossed titanium



“

Il design, di matrice brutalista, si esprime in una base in cemento articolata in quattro cilindri a mezzaluna che ricordano silos architettonici; da qui nasce il nome 'Bilbao', ispirato alla città emblema di rigenerazione urbana.

Its design, rooted in Brutalist aesthetics, is expressed through a concrete base divided into four crescent-shaped cylinders reminiscent of architectural silos; hence the name 'Bilbao', inspired by the city that serves as an emblem of urban rebirth.



▲ BILBAO GLASS table with cement base, embossed black frame and MIST glass sag. top

◀ BILBAO GLASS table with cement base, Oxybrass frame and extra clear bevelled glass top - GISELLE chairs in T30 D108 and burned oak frame - KIRAN rug oval. in Tortora colour

Gotham Keramik Drive

Design: Paolo Cattelan

Tavolo allungabile con base in acciaio verniciato goffrato titanio o bronzo con inserti in acciaio inox lucido. Piano e prolunghe in ceramica Marmi nei colori Alabastro, Golden Calacatta opaco, Golden Calacatta lucido, Portoro opaco, Portoro lucido, Sahara Noir lucido, Makalu, Breccia, Corcovado, Kaindy, Borghini Calacatta opaco, Borghini Calacatta lucido, Colosseo, Andromeda, Invisible opaco, Taj Mahal, Giava, Darwin o Luxor.

Extendible table with base in titanium or bronze embossed lacquered steel, with profiles in polished stainless steel. Marmi ceramic top and extensions in Alabastro, matt Golden Calacatta, glossy Golden Calacatta, matt Portoro, glossy Portoro, glossy Sahara Noir, Makalu, Breccia, Corcovado, Kaindy, matt Borghini Calacatta, glossy Borghini Calacatta, Colosseo, Andromeda, matt Invisible, Taj Mahal, Giava, Darwin or Luxor.

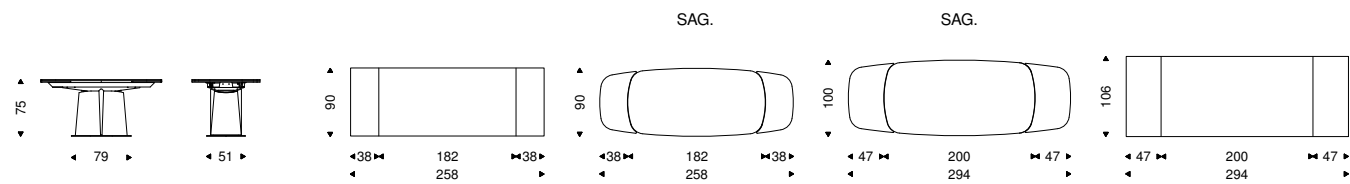

GOTHAM KERAMIK DRIVE table with embossed titanium base and Corcovado ceramic sag.

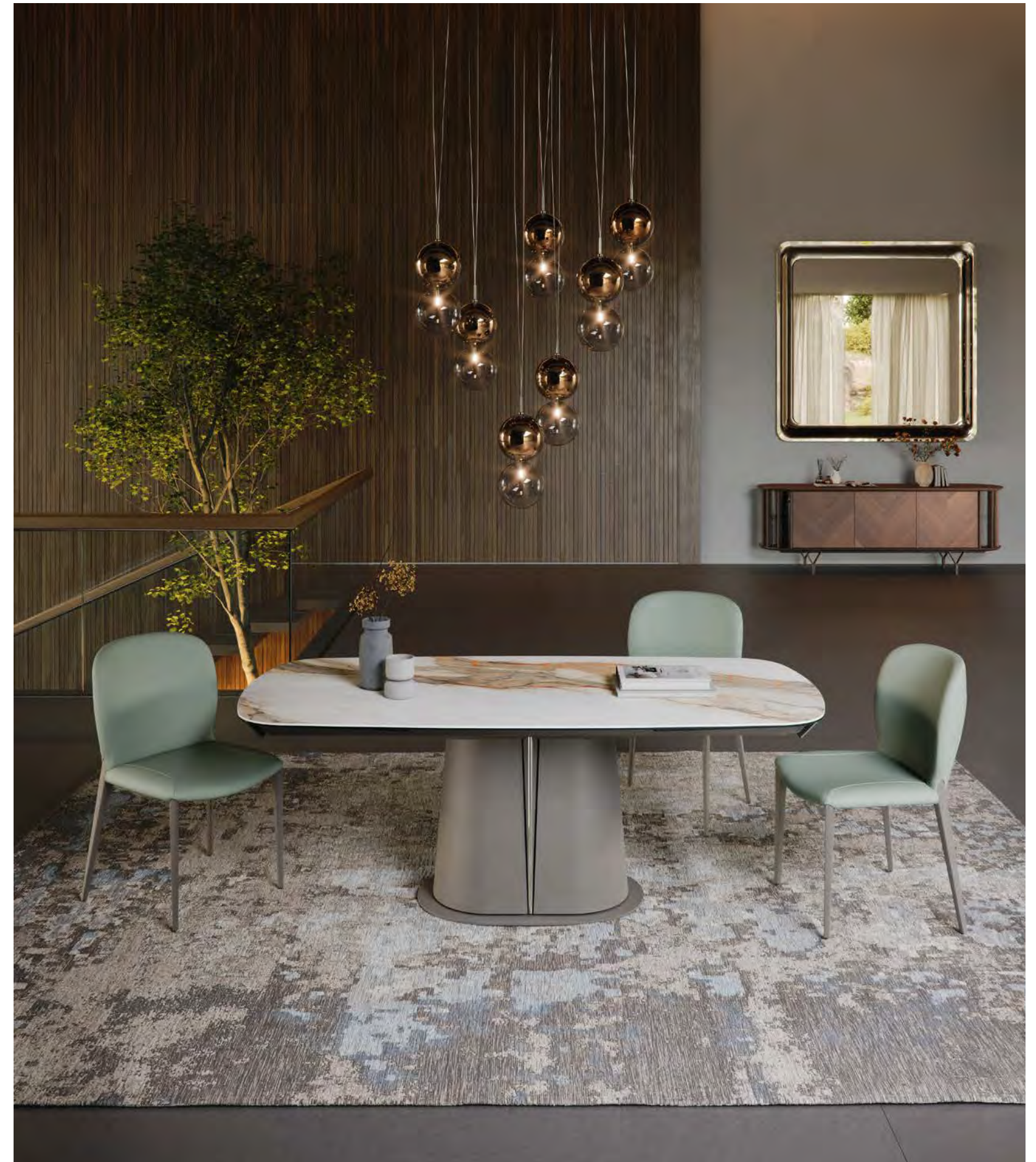

GOTHAM KERAMIK DRIVE table with embossed titanium base and matt Borghini Calacatta ceramic sag. top - NANCY ML chairs in glove soft leather GLV22 Botanico and embossed titanium frame
 APOLLO ceiling lamps - RADJA rug - COSTES sideboard in Canaletto walnut - GLENN MAGNUM mirror in bronze mirrored glass



GOTHAM KERAMIK DRIVE table with embossed titanium base and matt Borghini Calacatta ceramic sag. top - NANCY ML chairs in glove soft leather GLV22 Botanico and embossed titanium frame
RADJA rug - GIBSON sofa composition in fabric T20 B118

“

L'affascinante dettaglio della base si trasforma in un elemento vivo e dinamico: uno spigolo in acciaio specchiato che riflette lo spazio circostante, creando l'illusione ottica di uno squarcio nella struttura.

The distinctive detail of the base becomes a dynamic living element: a mirrored steel edge that reflects the surrounding space, creating the optical illusion of a break within the structure.



▲ GOTHAM KERAMIK DRIVE table with embossed bronze base and Corcovado ceramic sag. top

◀ GOTHAM KERAMIK DRIVE table with embossed titanium base and matt Borghini Calacatta ceramic sag. top - NANCY ML chairs in glove soft leather GLV22 Botanico and embossed titanium frame

Senator Keramik Magnum

Design: Paolo Cattelan

Tavolo con base in acciaio verniciato goffrato titanio o bronzo. Piano in ceramica Marmi nei colori Alabastro, Golden Calacatta opaco, Golden Calacatta lucido, Portoro opaco, Portoro lucido, Sahara Noir lucido, Makalu, Breccia, Corcovado, Kaindy, Borghini Calacatta opaco, Borghini Calacatta lucido, Colosseo, Andromeda, Invisible opaco, Taj Mahal, Giava, Darwin o Luxor con dettagli in noce Canaletto. Fondo in MDF verniciato goffrato in tinta con la base. Il top della versione da 400 cm viene fornito smontato in 3 parti, il top della versione da 600 cm viene fornito smontato in 4 parti.

Table with embossed lacquered titanium or bronze steel base. Top in ceramic Marmi Alabastro, matt Golden Calacatta, glossy Golden Calacatta, matt Portoro, glossy Portoro, glossy Sahara Noir, Makalu, Breccia, Corcovado, Kaindy, matt Borghini Calacatta, glossy Borghini Calacatta, Colosseo, Andromeda, matt Invisible, Taj Mahal, Giava, Darwin or Luxor with details in Canaletto walnut. Lower part in lacquered embossed MDF matching the base. Top supplied in 3 parts in the 400 cm version, 4 parts in the 600 cm version.

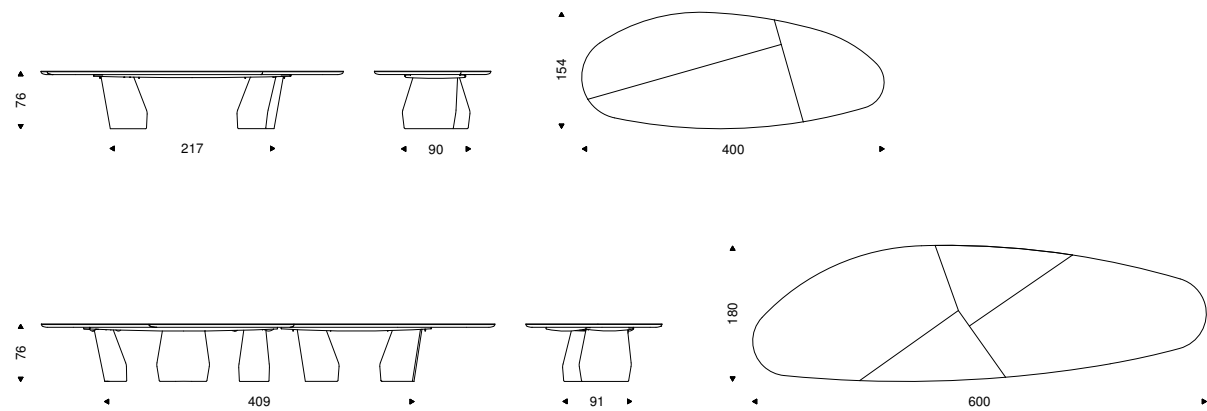

SENATOR KERAMIK MAGNUM 4.0 table with embossed bronze base and Taj Mahal ceramic top

Senator Keramik Magnum

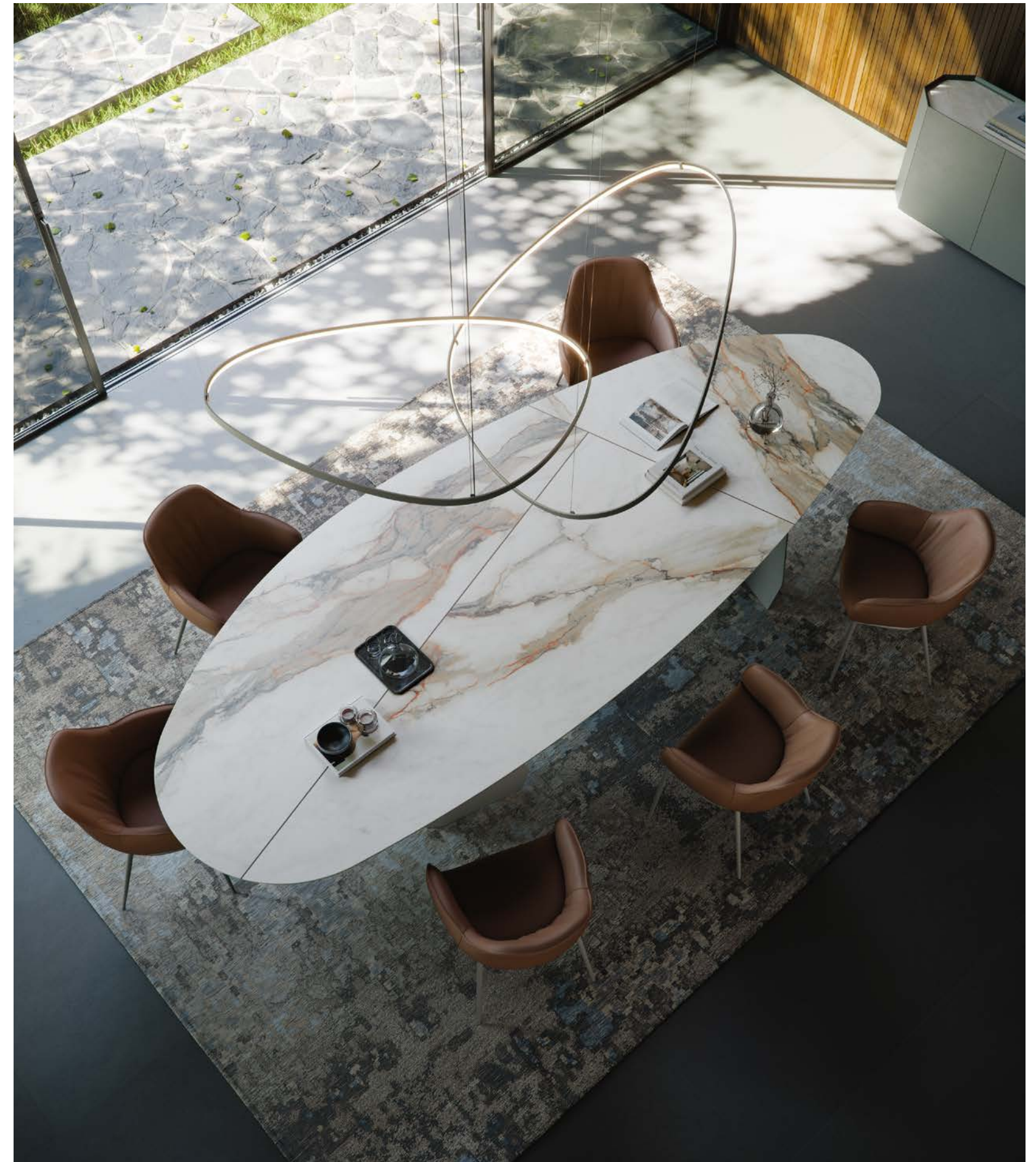

SENATOR KERAMIK MAGNUM 4.0 table with embossed titanium base and matt Borghini Calacatta ceramic top - SCARLETT ML chairs in glove soft leather GLV18 Barrique and embossed titanium frame - RADJA rug MAGELLANO ceiling lamps - CHELSEA sideboard in Mint with Taj Mahal ceramic top



SENATOR KERAMIK MAGNUM 4.0 table with embossed titanium base and matt Borghini Calacatta ceramic top - SCARLETT ML chairs in glove soft leather GLV18 Barrique and embossed titanium frame - RADJA rugs
MAGELLANO ceiling lamps - CHELSEA sideboard in Mint with Taj Mahal ceramic top - ASCOT MAGNUM mirror in bronze mirrored glass - GIBSON sofa composition in fabric T20 B118



“

Come un puzzle irregolare, il fitto intreccio di incastri spezza la continuità del piano in ceramica e ne valorizza la profondità. L'accostamento dei materiali crea spontaneamente un disegno pittorico, valorizzato dagli inserti in legno massello.

Like an irregular puzzle, a dense network of joints breaks the continuity of the ceramic top, enhancing its depth. The combination of materials spontaneously creates a pictorial pattern, further highlighted by the solid wood inserts.



▲ SENATOR KERAMIK MAGNUM 4.0 table with embossed bronze base and Taj Mahal ceramic top

◀ SENATOR KERAMIK MAGNUM 4.0 table with embossed titanium base and matt Borghini Calacatta ceramic top - RHONDA chair in soft leather 953 Ardesia and embossed bronze frame - SENDAI rug



SENATOR KERAMIK MAGNUM 4.0 table with embossed titanium base and matt Borghini Calacatta ceramic top - BRITNEY TURN swivelling armchairs in fabric B206
SENDAI rug - SAN MARCO ceiling lamps with Rigadin and artistic shaded glass in Verde colour



“

Cattelan Italia spinge i limiti della progettazione realizzando un piano in ceramica da sei metri. Le nuove dimensioni rafforzano la presenza scenografica della famiglia Senator, capace di definire l'ambiente che la circonda.

Cattelan Italia pushes the boundaries of design with a six-meter ceramic top. These new dimensions enhance the dramatic presence of the Senator family, capable of defining the space around it.



▲ SENATOR KERAMIK MAGNUM 6.0 table with embossed titanium base and Darwin ceramic top

◀ SENATOR KERAMIK MAGNUM 6.0 table with embossed bronze base and Corcovado ceramic top - GRETA WOOD chairs in fabric B714 and burned oak frame - MADRAS rugs in Beige colour - BLOOM ceiling lamps



SENATOR KERAMIK MAGNUM 6.0 table with embossed bronze base and Corcovado ceramic top - GRETA WOOD chairs in fabric B714 and burned oak frame
MADRAS rugs in Beige colour - BLOOM ceiling lamps - ARIZONA sideboard in Brushed Bronze

Skorpio Marble

Design: A. Lucatello & P. Cattelan

Tavolo con base in acciaio verniciato goffrato titanio, bronzo, graphite, pearl o nero, Brushed Bronze o Brushed Grey. Piano in marmo Lepanto, Avocatus o Onda Grigia. Variazioni cromatiche e di spazzolatura della finitura Brushed sono caratteristiche della lavorazione artigianale e non sono da considerarsi difetti.

Table with base in titanium, bronze, graphite, pearl, or black embossed lacquered steel, Brushed Bronze or Brushed Grey lacquered steel. Marble top in Lepanto, Avocatus or Onda Grigia. Colour and brushing variations of the Brushed finish are characteristics of the handcrafted processing and should not be considered as defects.

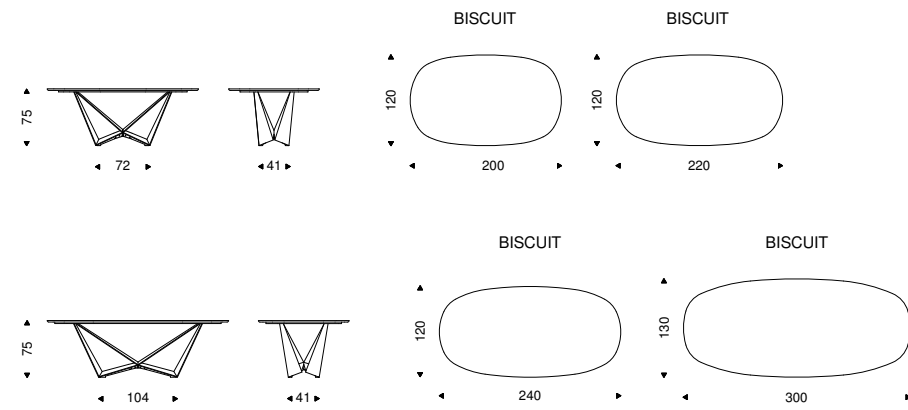

SKORPIO MARBLE table with embossed bronze base and Avocatus marble top



SKORPIO MARBLE table with embossed bronze base and Lepanto marble top - GRETA chairs in fabric D187 and embossed bronze frame - KIRAN rug oval, in Tortora colour - PLANETA ceiling lamps
SAVOY sideboard in embossed bronze with bronze mirrored glass top - COSMOS mirror in bronze mirrored glass



Tyron Marble

Design: Paolo Cattelan

Tavolo con base in acciaio verniciato gofrato titanio, bronzo, graphite o nero, Brushed Bronze o Brushed Grey. Piano in marmo Lepanto, Avocatus o Onda Grigia. Variazioni cromatiche e di spazzolatura della finitura Brushed sono caratteristiche della lavorazione artigianale e non sono da considerarsi difetti.

Table with base in titanium, bronze, graphite or black embossed lacquered steel, Brushed Bronze or Brushed Grey. Marble top in Lepanto, Avocatus or Onda Grigia. Colour and brushing variations of the Brushed finish are characteristics of the handcrafted processing and should not be considered as defects.

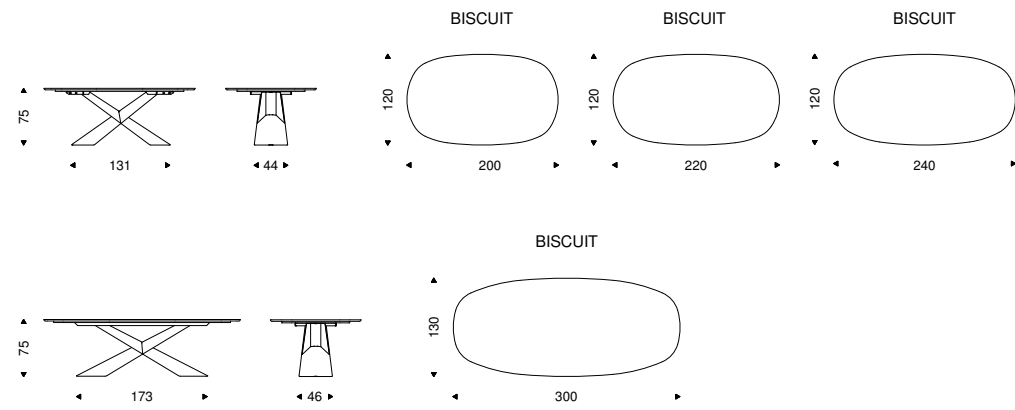

TYRON MARBLE table with embossed bronze base and Onda Grigia marble top



TYRON MARBLE table with Brushed Bronze base and Avocatus marble top - SCARLETT ML chairs in glove soft leather GLV20 Senape and embossed bronze frame - COIMBRA ceiling lamps with inner shell in painted bronze KIRAN rug hex. in Etrusco colour - WISH MAGNUM mirror in Brushed Bronze - BOUTIQUE sideboard in soft leather 937 Palladio

Papel Marble

Design: M. Fanti & P. Cattelan

Tavolo con base in acciaio verniciato gofrato titanio, bronzo, Oxybrass o Oxygrey. Piano in marmo Lepanto, Avocatus o Onda Grigia.

Table with embossed lacquered titanium, bronze, Oxybrass or Oxygrey steel base. Marble top in Lepanto, Avocatus or Onda Grigia.

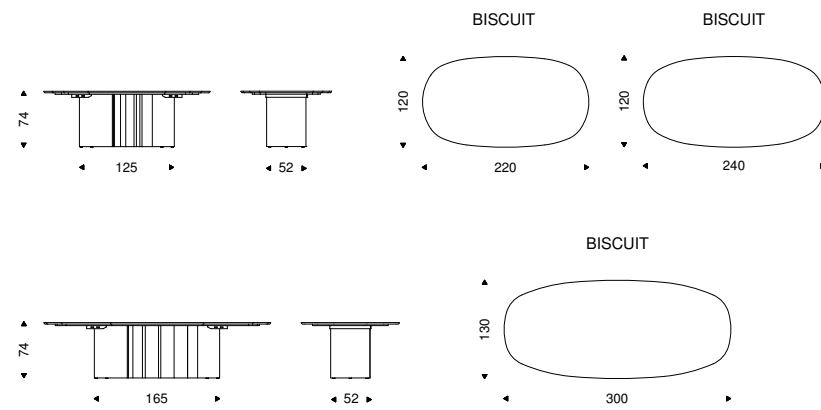

38

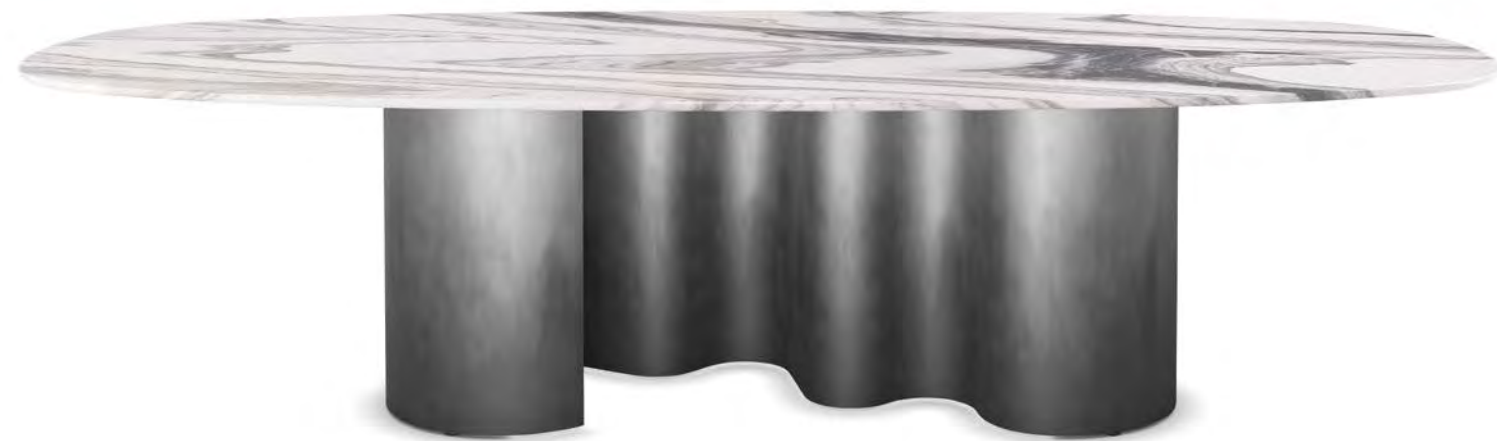

PAPEL MARBLE table with Oxygrey base and Onda Grigia marble top

Giano Marble

Design: Manzoni & Tapinassi & P. Cattelan

Tavolo con base in acciaio verniciato gofrato titanio, bronzo, graphite, pearl o nero. Piano in marmo Lepanto, Avocatus o Onda Grigia.

Table with base in titanium, bronze, graphite, pearl or black embossed lacquered steel. Marble top in Lepanto, Avocatus or Onda Grigia.

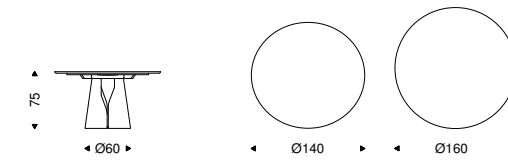

39



GIANO MARBLE table with black embossed base and Avocatus marble top

Yoda Marble

Design: Paolo Cattelan

Tavolo con base in acciaio verniciato gofrato bronzo, graphite, pearl, nero o titanio satinato. Piano in marmo Lepanto, Avocatus o Onda Grigia.

Table with base in bronze, graphite, pearl, black embossed lacquered steel or satin titanium steel. Marble top in Lepanto, Avocatus or Onda Grigia.

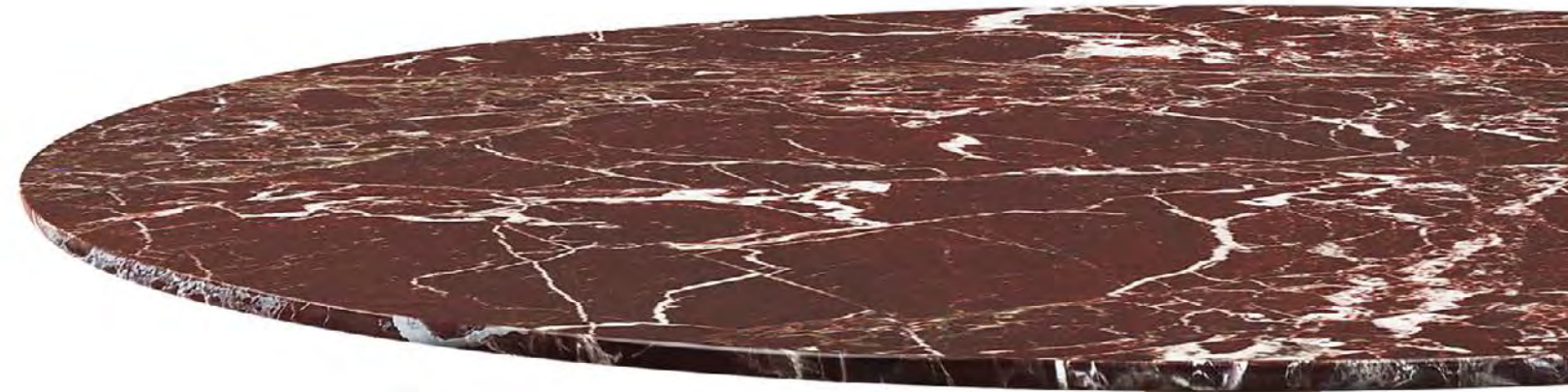
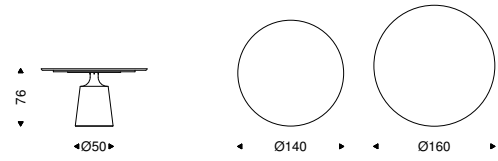

YODA MARBLE table with embossed bronze base and Avocatus marble top



YODA MARBLE table with satin titanium base and Lepanto marble top

Skorpio Marble Round

Design: A. Lucatello & P. Cattelan

Tavolo con base in acciaio verniciato gofrato titanio, bronzo, graphite, pearl o nero, Brushed Bronze o Brushed Grey. Piano in marmo Lepanto, Avocatus o Onda Grigia. La versione ø140 top legno monta una piastra zavorra di base. Variazioni cromatiche e di spazzolatura della finitura Brushed sono caratteristiche della lavorazione artigianale e non sono da considerarsi difetti.

Table with base in titanium, bronze, graphite, pearl, or black embossed lacquered steel, Brushed Bronze or Brushed Grey lacquered steel. Marble top in Lepanto, Avocatus or Onda Grigia. The ø140 cm version with wooden top includes a ballast on the base. Colour and brushing variations of the Brushed finish are characteristics of the handcrafted processing and should not be considered as defects.

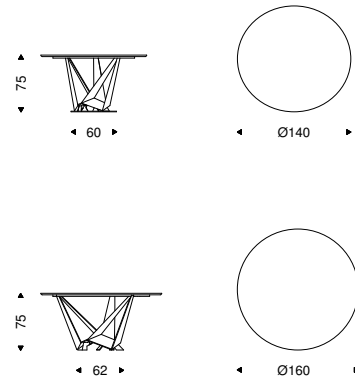

SKORPIO MARBLE ROUND table with embossed titanium base and Onda Grigia marble top

Rado Keramik Round Outdoor

Design: Paolo Cattelan

Tavolo con piano e base in ceramica Marmi nei colori Portoro opaco, Borghini Calacatta opaco, Colosseo, Invisible opaco o Taj Mahal. Imperfezioni, variazioni cromatiche e irregolarità di forma della base sono caratteristiche della lavorazione e non sono da considerarsi difetti.

Table with top and base in ceramic Marmi matt Portoro, matt Borghini Calacatta, Colosseo, matt Invisible or Taj Mahal. Imperfections, colour variations and irregularities on the base are characteristics of the workmanship and are not to be considered defects.

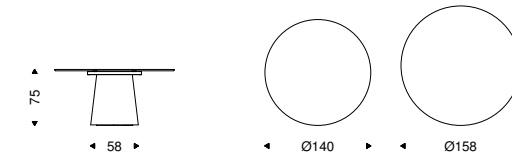

RADO KERAMIK OUTDOOR table in Colosseo ceramic

Napoleon Keramik Outdoor

Design: Paolo Cattelan

Tavolo outdoor con piano e base in ceramica Marmi nei colori Portoro, Borghini Calacatta opaco, Colosseo, Invisible opaco o Taj Mahal. Piano in appoggio. Imperfezioni, variazioni cromatiche e irregolarità di forma della base sono caratteristiche della lavorazione e non sono da considerarsi difetti. Il prodotto è destinato ad uno spazio esterno coperto, non esposto direttamente agli agenti atmosferici.

Outdoor table with top and base in ceramic Marmi matt Portoro, matt Borghini Calacatta, Colosseo, matt Invisible or Taj Mahal. The top is laid on the base. Imperfections, colour variations and irregularities on the base are characteristics of the workmanship and are not to be considered defects. The product is intended for a covered outdoor area, which is not directly exposed to atmospheric agents.

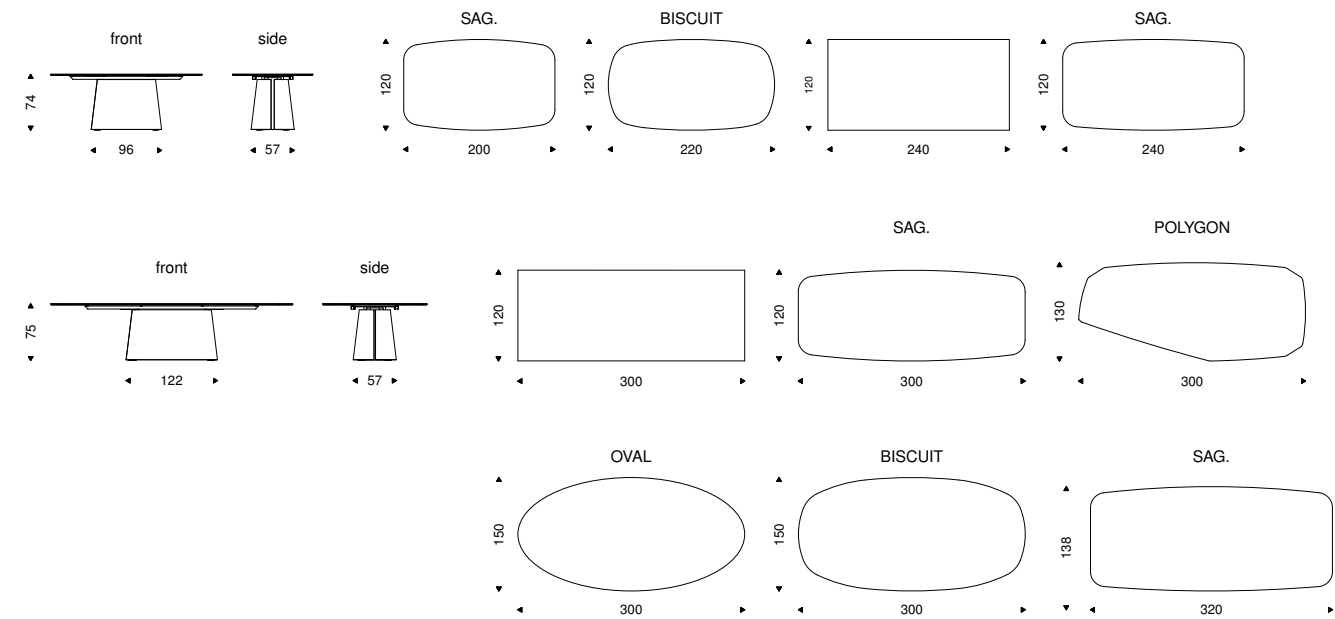

NAPOLEON KERAMIK OUTDOOR table in Taj Mahal ceramic



NAPOLEON KERAMIK OUTDOOR table in matt Borghini Calacatta ceramic - GRETA OUTDOOR chairs with embossed titanium frame



46

47

Boston

Design: Paolo Cattelan

Scrivania con piano in noce Canaletto o rovere bruciato con il fondo verniciato gofrato bronzo e inserto in cuoio nei colori come da campionario. Gambe in legno verniciato gofrato bronzo con particolari in acciaio cromato. Disponibile in versione con cassetto (B) in legno verniciato gofrato bronzo o senza cassetto (A).

Desk with top in Canaletto walnut or burned oak with lower part in bronze embossed lacquered wood and insert in leather as per sample card. Legs in bronze embossed lacquered wood with details in chromed steel. Available in the version with drawer (B) in bronze embossed lacquered wood or without drawer (A).

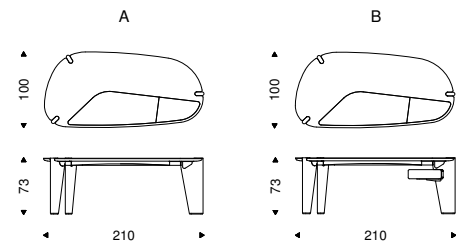

48



BOSTON A desk with top in burned oak and insert in leather 82 Cognac

Boston



49

BOSTON B desk with top in burned oak and insert in leather 21 Oliva - BRITNEY TURN swivelling armchair in fabric B202 - KIRAN rug in Tortora colour - ADDRESS bookcase in burned oak and embossed bronze frame



BOSTON B desk with top in burned oak and insert in Oliva Leather - BRITNEY TURN swivelling armchair in fabric B202 - KIRAN rug in Tortora colour - ADDRESS bookcases in burned oak and embossed bronze frame
BALDWIN sofas MIX with A part in fabric B207 and B part in glove soft leather GLW18 Barrique - BLISS 45x45 cushions in fabrics T80 B096 and T60 D037 - LAGOON coffee table with Canaletto walnut base
KIMI in White colour - ETOILE consoles in Brushed Bronze - WISH mirror in Brushed Bronze

Giselle

Design: Maurizio Manzoni

Sedia con braccioli con struttura in frassino naturale, frassino tinto noce Canaletto, frassino tinto rovere bruciato o frassino laccato poro aperto nero opaco. Seduta e schienale rivestiti in tessuto, micro nubuck, ecopelle o pelle come da campionario. Non sfoderabile.

Chair with arms with frame in natural ashwood, Canaletto walnut stained ashwood, burned oak stained ashwood or open pore matt black ashwood. Seat and back upholstered in fabric, micro nubuck, synthetic leather or soft leather as per sample card. The cover is not removable.

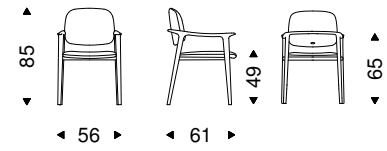

GISELLE chair in fabric B192 and burned oak frame

Giselle



GISELLE chair in fabric B730 and burned oak frame - RADO KER-WOOD ROUND table with base and insert in Colosseo ceramic and burned oak top - KIRAN rug in Etrusco colour - GLENN mirror in bronze mirrored glass



Charlotte

Design: Luca Signoretti

Poltroncina con rivestimento frontale in tessuto e retro in pelle come da campionario. Struttura in acciaio verniciato goffrato titanio, bronzo o nero. Non sfoderabile.

Armchair with front upholstery in fabric and back upholstery in soft leather as per sample card. Frame in titanium, bronze or black embossed lacquered steel. The cover is not removable.

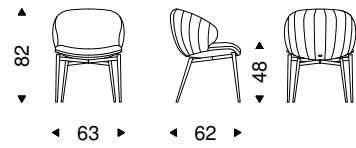

Charlotte



CHARLOTTE chairs with seat in fabric B200, back in soft leather 951 Castoro and embossed bronze frame - BOTERO KERAMIK table with Cairo argille base and Luxor ceramic top - SENDAI rug AMSTERDAM KERAMIK sideboard in Colosseo ceramic - RISIKO mirror

Magda Barrè

Design: Studio Kronos

Sedia con o senza braccioli con struttura in frassino naturale, frassino tinto noce Canaletto, frassino tinto rovere bruciato, frassino laccato poro aperto nero opaco. Seduta e schienale rivestiti in ecopelle o pelle come da campionario. Retro schienale trapuntato. Non sfoderabile. (Disponibile anche in versione sgabello).

Chair with or without arms with frame in natural ashwood, Canaletto walnut stained ashwood, burned oak stained ashwood, open pore matt black painted ashwood. Seat and back upholstered in synthetic leather or soft leather as per sample card. Quilted seatback cover. The cover is not removable. (Stool version is available).

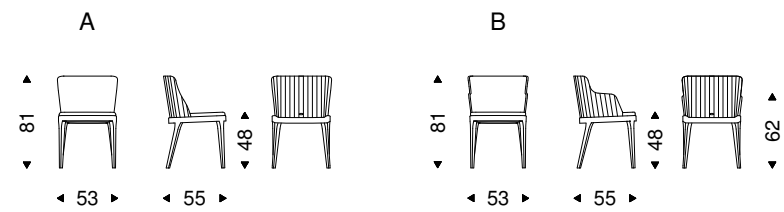

MAGDA BARRÈ B chair in glove soft leather GLV20 Senape and burned oak frame

Magda Barrè



MAGDA BARRÈ B chair in glove soft leather GLV20 Senape and burned oak frame - SENATOR WOOD table with embossed bronze base and burned oak Y top - SENDAI rug
AMSTERDAM sideboard - GLENN mirrors in bronze mirrored glass

Magda ML Barrè

Design: Studio Kronos

Sedia con o senza braccioli con struttura in acciaio cromato o verniciato gofrato titanio, bronzo, graphite, pearl o nero. Rivestimento in ecopelle o pelle come da campionario. Retro schienale trapuntato. Non sfoderabile.

Chair with or without arms with frame in chromed steel or titanium, bronze, graphite, pearl or black embossed lacquered steel. Cover in soft leather or synthetic leather as per sample card. Quilted seatback cover. The cover is not removable.

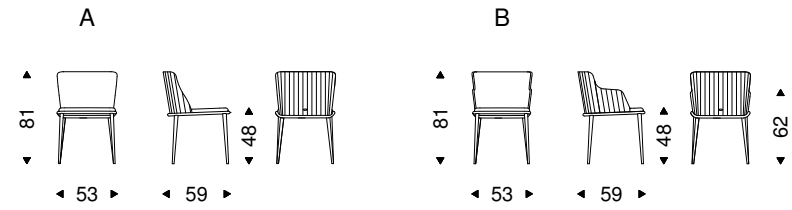

MAGDA ML BARRÈ B chairs in glove soft leather GLV18 Barrique and embossed bronze frame - TYRON KERAMIK table with Brushed Grey base and Darwin ceramic top
KIMI rug in Salvia colour - AIRPORT bookcase in burned oak and embossed graphite frame

Britney Turn

Design: Castello Lagravinese Studio

Poltroncina girevole con rivestimento in tessuto come da campionario. Non sfoderabile.

Swiveling armchair covered in fabric as per sample card. The cover is not removable.

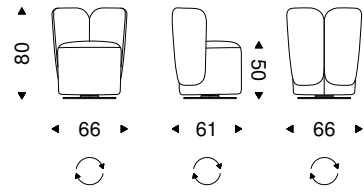

BRITNEY TURN swiveling armchair in fabric B206

Britney Turn



BRITNEY TURN swiveling armchair in fabric B206 - COCOON TROUSSE KERAMIK desk with embossed bronze base and Breccia ceramic top - SENDAI rug



“

Britney Turn nasce come sedia girevole freestanding, ideale per ambienti domestici e commerciali. Rappresenta l'anima più glamour della collezione, con il suo schienale formato da due "petali" imbottiti, decorativi quanto funzionali.

Britney Turn is designed as a freestanding swivel chair, ideal for both residential and commercial spaces. It represents the most glamorous soul of the collection, featuring a backrest composed of two padded "petals" that are as decorative as they are functional.



Greta Wood

Design: Paolo Cattelan

Sedia con braccioli con struttura in noce Canaletto o frassino tinto rovere bruciato. Seduta e schienale rivestiti in tessuto, micro nubuck, ecopelle o pelle come da campionario. Non sfoderabile.

Chair with frame in Canaletto walnut or burned oak stained ashwood. Seat and back upholstered in fabric, micro nubuck, synthetic leather or soft leather as per sample card. The cover is not removable.

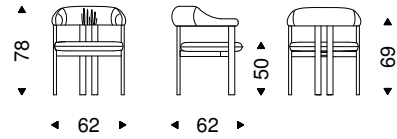

GRETA WOOD chair in glove soft leather GLV11 Taupe and burned oak frame



GRETA WOOD chairs in fabric B714 and Canaletto walnut frame - MADRAS rugs in Beige colour

Greta Outdoor

Design: Paolo Cattelan

Sedia da esterno con struttura in acciaio inox 304 verniciato goffrato titanio, bronzo, graphite, pearl o nero. Rivestimento in tessuto come da campionario. Non sfoderabile. Il prodotto è destinato ad uno spazio esterno coperto, non esposto direttamente agli agenti atmosferici.

Outdoor chair with frame in titanium, bronze, graphite, pearl or black embossed lacquered inox 304 steel. Cover in fabric as per sample card. The cover is not removable. The product is intended for a covered outdoor area, which is not directly exposed to atmospheric agents.

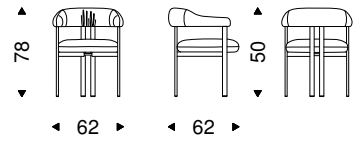

GRETA OUTDOOR chair with embossed titanium frame



GRETA OUTDOOR chairs with embossed titanium frame - NAPOLEON KERAMIK OUTDOOR table in matt Borghini Calacatta ceramic

Magda Barrè Sgabello

Design: Studio Kronos

Sgabello con o senza braccioli con struttura in frassino naturale, frassino tinto noce Canaletto, frassino tinto rovere bruciato, frassino laccato poro aperto nero opaco. Seduta e schienale rivestiti in ecopelle o pelle come da campionario. Retro schienale trapuntato. Non sfoderabile.

Stool with or without arms with frame in natural ashwood, Canaletto walnut stained ashwood, burned oak stained ashwood, open pore matt black painted ashwood. Seat and back upholstered in synthetic leather or soft leather as per sample card. Quilted seatback cover. The cover is not removable.

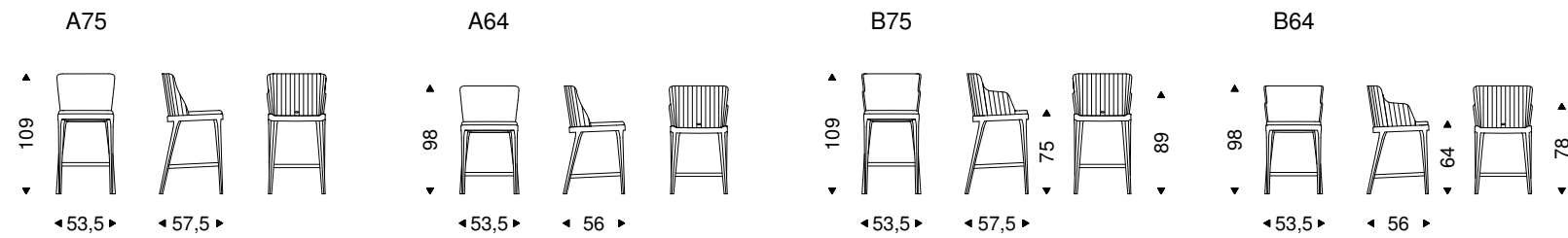

Magda ML Barrè Sgabello

Design: Studio Kronos

Sgabello con o senza braccioli con struttura in acciaio verniciato gofrato titanio, bronzo, graphite, pearl o nero. Rivestimento in ecopelle, micro nubuck o pelle come da campionario. Retro schienale trapuntato. Non sfoderabile.

Stool with or without arms with frame in titanium, bronze, graphite, pearl or black embossed lacquered steel. Cover in micro nubuck, soft leather or synthetic leather as per sample card. Quilted seatback cover. The cover is not removable.

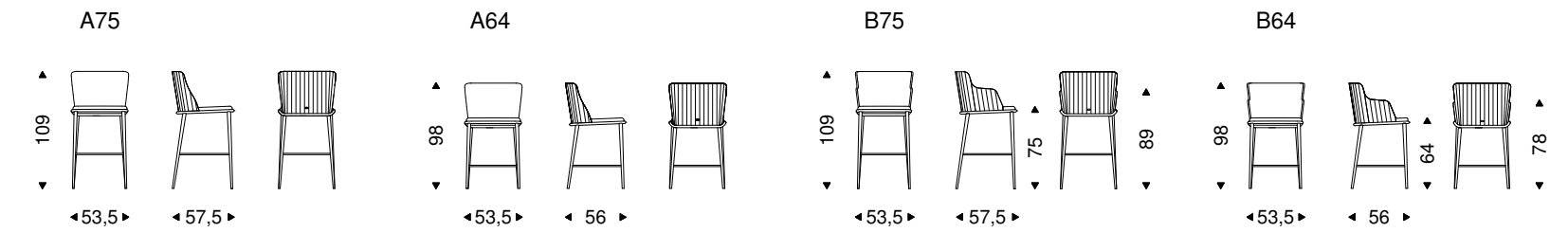

MAGDA BARRÈ B64 stool in soft leather GLV20 Senape and burned oak frame



MAGDA ML BARRÈ B64 stool in soft leather GLV11 Taupe and embossed bronze frame

Baldwin

Design: Maurizio Manzoni

Divano singolo o componibile con struttura in legno, imbottitura in poliuretano e piedini in abs. Rivestimento in tessuto come da campionario. Versione mix: parte "A" in tessuto come da campionario. Parte "B" in pelle o pelle glove. Rivestimento A sfoderabile, rivestimento B non sfoderabile.

Sofa or modular sofa with wooden frame, polyurethane padding and thermoplastic feet. Cover in fabric as per sample card. Mix version: "A" part in fabric as per sample card. "B" part in soft leather or Glove soft leather. A cover is removable, B cover is not removable.



BALDWIN sofa in fabric T20 F170 - COMFY 65x30 cushion in glove soft leather GLW18 Barrique

Baldwin



BALDWIN sofa MIX with A part in fabric T30 D081 and B part in glove soft leather GLW07 Argo - BLISS 55x30 cushion in glove soft leather GLW07 Argo - BLISS 45x45 cushion in fabric T30 F102
MATERA coffee tables in beige - MADRAS rug in Beige colour



74

75

BALDWIN sofas MIX with A part in fabric T30 D081 and B part in glove soft leather GLW07 Argo - BLISS 55x30 cushion in glove soft leather GLW07 Argo - BLISS 45x45 cushions in fabric T30 F102 - MATERA coffee tables in beige MADRAS rug in Beige colour - SAN MARCO ceiling lamps with Rigadin and artistic shaded glass in Pesca colour - COSTES sideboard in burned oak - ASCOT mirror in bronze mirrored glass



“

Baldwin: un'opera monumentale di design, fatta di volumi fluidi e sinuosi, scolpiti, in apparenza, dal movimento stesso. Lo schienale sembra prendere vita, ricopre la seduta come un morbido manto e ne disegna la silhouette, facendosi bracciolo.

Baldwin: a monumental design piece defined by fluid, sinuous volumes that appear sculpted by movement itself. The backrest seems to come alive, draping over the seat like a soft mantle and tracing its silhouette as it seamlessly morphs into the armrest.



▲ BALDWIN sofa MIX with A part in fabric B202 and B part in glove soft leather GLW12 Oliva - COMFY 65x30 cushion in glove soft leather GLW07 Argo

◀ BALDWIN sofa MIX with A part in fabric T30 D081 and B part in glove soft leather GLW07 Argo - BLISS 45x45 cushion in fabric T30 F102 - MADRAS rug in Beige colour



BALDWIN sofas MIX with A part in fabric B207 and B part in glove soft leather GLW18 Barrique - BLISS 45x45 cushions in fabrics T80 B096 and T60 D037 - PEGGY TURN swivelling armchairs in Nabuk soft leather P03 NK57
LAGOON coffee tables with Canaletto walnut base - KIMI rug in White colour - ALADDIN ceiling lamps in Balloton fumé glass - ETOILE consoles in Brushed Bronze
WISH mirror in Brushed Bronze - ADDRESS bookcases in Canaletto walnut and embossed titanium frame



BALDWIN sofa composition MIX with A part in fabric B206 and B part in glove soft leather GLW07 Argo - BLISS 55x55 cushions in fabric T30 F102 - BLISS 45x45 cushions in fabrics D186 and B206
BLISS 55x30 cushion in glove soft leather GLW07 - STANDARD coffee tables - STEP side table in Brushed Brass - RADJA rug - CHELSEA sideboard in Mint with bronze mirrored glass top



BALDWIN sofa composition MIX with A part in fabric B206 and B part in glove soft leather GLW07 Argo - BLISS 45x45 cushions in fabrics D186 and B206
BLISS 45x45 cushions in fabric D186 - RADJA rug - CHELSEA sideboard in Mint with bronze mirrored glass top

Gibson

Design: Sergio Bicego

Divano componibile con struttura in legno, imbottitura in poliuretano e piedini in abs. Cuscini schienale in mistopiuma. Rivestimento in tessuto come da campionario. Modulo tavolino con inserto in ceramica Marmi nei colori Alabastro, Golden Calacatta opaco, Golden Calacatta lucido, Portoro opaco, Portoro lucido, Sahara Noir lucido, Makalu, Breccia, Corcovado, Kaindy, Borghini Calacatta opaco, Borghini Calacatta lucido, Colosseo, Andromeda, Invisible opaco, Taj Mahal, Giava, Darwin o Luxor. Rivestimento sfoderabile.

Modular sofa with wooden frame, polyurethane padding and thermoplastic feet. Feather filled cushions. Cover in fabric as per sample card. Module with top in Marmi ceramic Alabastro, matt Golden Calacatta, glossy Golden Calacatta, matt Portoro, glossy Portoro, glossy Sahara Noir, Makalu, Breccia, Corcovado, Kaindy, matt Borghini Calacatta, glossy Borghini Calacatta, Colosseo, Andromeda, matt Invisible, Taj Mahal, Giava, Darwin or Luxor. Removable cover.



GIBSON sofa in fabric T20 F170 - BLISS 45x45 and 55x55 cushions in fabric T90 D188

Gibson



GIBSON sofa composition in fabric B198 - COMFY 50x50 and 65x30 cushions in fabrics B202 and B196 - MATERA coffee tables in beige - BISHOP side tables in Smeraldo colour
KIMI rug in Salvia colour - FREEWAY bookcase in embossed bronze



GIBSON sofa composition in fabric B198 - COMFY 50x50 and 65x30 cushions in fabrics B202 and B196 - MATERA coffee tables in beige - BISHOP side tables in Smeraldo colour
KIMI rugs in Salvia colour - FREEWAY bookcase in embossed bronze



GIBSON sofa composition in fabric T20 B118 - COMFY 50x50 and 65x30 cushions in fabric T70 F012 - STANDARD coffee tables - MAPOON rugs - KATANA ceiling lamps
CHELSEA sideboard in Mint with Taj Mahal ceramic top - ASCOT MAGNUM mirror in bronze mirrored glass



GIBSON sofa composition in fabric T20 B118 - COMFY 50x50 and 65x30 cushions in fabric T70 F012 - STANDARD coffee tables - MAPOON rugs - KATANA ceiling lamps
CHELSEA sideboard in Mint with Taj Mahal ceramic top - ASCOT MAGNUM mirror in bronze mirrored glass



GIBSON sofa composition in fabric T80 B096 - BLISS 45x45 cushions in fabrics T70 B132 and T70 F013 - AMALFI side tables with embossed bronze base, Brushed Bronze column and Corcovado ceramic top
MADRAS rug in Ivory colour - AIRPORT bookcase in burned oak and embossed bronze frame



94

95

GIBSON sofa composition in fabric T80 B096 - BLISS 45x45 cushions in fabrics T70 B132 and T70 F013 - AMALFI side tables with embossed bronze base, Brushed Bronze column and Corcovado ceramic top
MADRAS rug in Ivory colour - AIRPORT bookcase in burned oak and embossed bronze frame - PIGALLE floor lamp - SCARLETT chairs in glove soft leather GLV18 Barrique - RADJA rug

Murphy

Design: Maurizio Manzoni

Divano componibile con struttura in legno, imbottitura in poliuretano e piedini in abs. Rivestimento in tessuto come da campionario. Schienali composti da cuscini riposizionabili con un contrappeso di bilanciamento. Rivestimento sfoderabile.

Modular sofa with wooden frame, polyurethane padding and thermoplastic feet. Cover in fabric as per sample card. Adaptable backrest cushions equipped with counterweights. Removable cover.



MURPHY sofa composition in fabric T20 D113 - COMFY cushions in fabric T80 F021

Murphy



MURPHY sofa composition in fabric T20 D113 - COMFY cushion in fabric T80 F021 - BLISS 45x45 cushion in fabric T30 F102
LAGOON coffee tables with Canaletto walnut base - SENDAI rug



MURPHY sofa composition in fabric T20 D113 - MURPHY PILLOW in fabric T20 D113 - BLISS 45x45 cushion in fabric T30 F102 - LAGOON coffee tables with Canaletto walnut base
FELIX trolley bar with embossed titanium base and Giava ceramic top - SENDAI rug



MURPHY sofa composition in fabric T20 D113 - MURPHY PILLOW in fabric T20 D113 - BLISS 45x45 cushion in fabric T30 F102 - LAGOON coffee tables with Canaletto walnut base
SENDAI rug - NETTUNO console with Oxybrass base and MIST glass top

Margaret

Design: Sergio Bicego

Poltrona con struttura in acciaio verniciato gofrato titanio, bronzo o nero. Rivestimento in tessuto, micro nubuck o pelle come da campionario. Non sfoderabile.

Armchair with base in titanium, bronze or black embossed lacquered steel. Cover in fabric, micro nubuck or soft leather as per sample card. The cover is not removable.

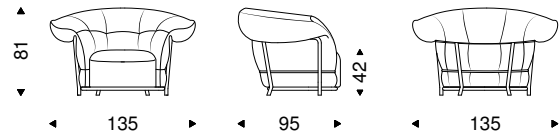

MARGARET armchair in fabric T20 B057 and embossed bronze frame

Margaret



MARGARET armchair in fabric T50 D026 and embossed bronze frame - PEYOTE side tables with titanium base and bronze mirrored glass top - RADJA rug



Peggy Turn

Design: Castello Lagravinese Studio

Poltrona girevole con rivestimento in tessuto, micro nubuck o pelle come da campionario. Non sfoderabile.

Swiveling armchair covered in fabric, micro nubuck or soft leather as per sample card. The cover is not removable.

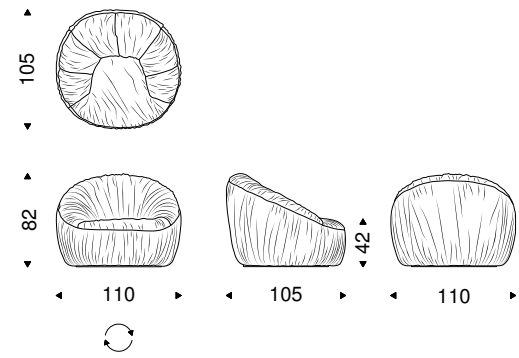



“

Peggy Turn fa dell'imbottitura oversize, tipica delle poltrone-pouf, l'essenza stessa del proprio design. Forme soffici e vaporose come una nuvola, e pieghe morbide, definite dal caso e dalla gravità, si modellano per adattarsi al corpo con naturalezza.

Peggy Turn embraces the oversized padding typical of lounge and pouf seating, making it the very essence of its design. Shapes as soft and airy as clouds, with gentle folds defined by chance and gravity, naturally adapt themselves to the body.



▲ PEGGY TURN swivelling armchair in Nabuk soft leather P03 NK96

◀ PEGGY TURN swivelling armchair in Nabuk soft leather P03 NK51 - BISHOP side tables in Etrusco colour - RADJA rug

Baldwin Turn

Design: Maurizio Manzoni

Poltrona girevole rivestita in tessuto o con seduta rivestita in tessuto (A) e retro con dettaglio in pelle o pelle Glove (B) come da campionario. Non sfoderabile.

Swivelling armchair covered in fabric or with seat covered in fabric (A) and back detail in soft leather or soft leather Glove (B) as per sample card. The cover is not removable.

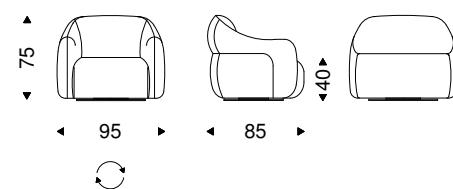

Giselle Lounge

Design: Maurizio Manzoni

Poltrona con struttura in frassino naturale, frassino tinto noce Canaletto, frassino tinto rovere bruciato o frassino laccato poro aperto nero opaco. Seduta e schienale rivestiti in tessuto, micro nubuck, ecopelle o pelle come da campionario. Non sfoderabile.

Armchair with frame in natural ashwood, Canaletto walnut stained ashwood, burned oak stained ashwood or open pore matt black ashwood. Seat and back upholstered in fabric, micro nubuck, synthetic leather or soft leather as per sample card. The cover is not removable.

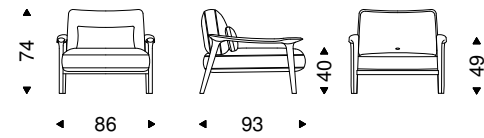

GISELLE LOUNGE armchair in fabric D189 and burned oak frame - COMFY 65x30 cushion in fabric T80 B096



GISELLE LOUNGE armchair in fabric D189 and natural ashwood frame - PENGUIN side table in embossed titanium - CRAIG sofa in fabric T80 B096 - MAPOON rugs - WISH mirror in Brushed Grey

Sierra Pouf

Design: Studio Kronos

Pouf imbottito e rivestito in tessuto o pelle come da campionario. Piedini in ABS.

Upholstered pouf covered in fabric or soft leather as per sample card. Thermoplastic feet.

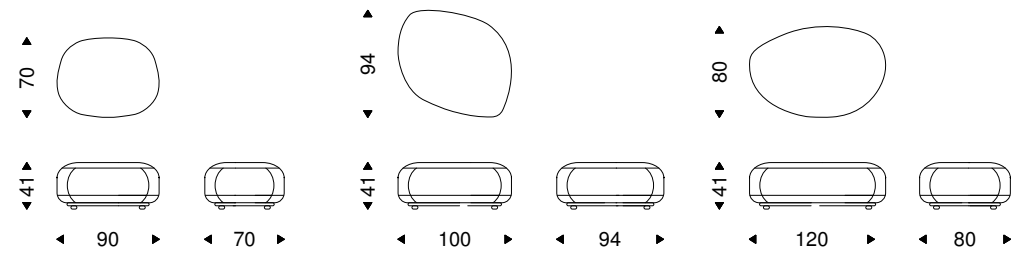

SIERRA POUF in glove soft leather GLW18 Barrique - CRAIG sofa in fabrics B199 and B206 - BLISS 55x30 cushions in glove soft leather GLW23 Amarone - MATERA coffee tables in beige
DODO coffee table with Melanzana glass top - YAGO side tables in Brushed Bronze - FELIX trolley bar embossed bronze base and Corcovado ceramic top - MADRAS rugs in Beige colour
VARENNE console with Brushed Bronze base and burned oak top

Matera

Design: Studio 28

Tavolino in legno laccato beige lucido.

Coffee table in beige polished lacquered wood.

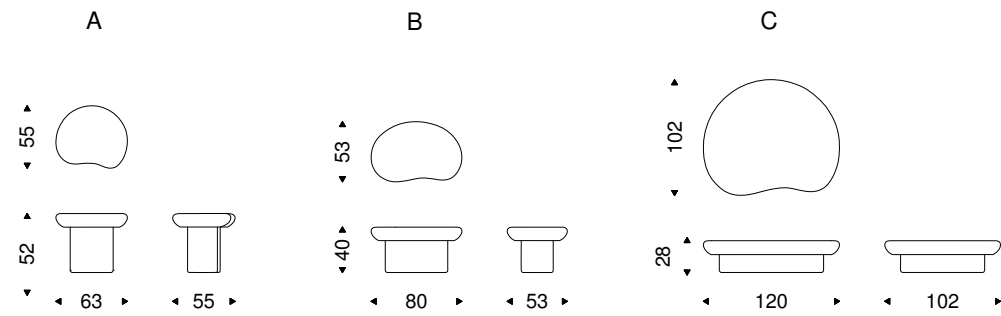

116



Matera



117

MATERA coffee tables in beige - BALDWIN sofa MIX with A part in fabric T30 D081 and B part in glove soft leather GLW07 Argo - BLISS 45x45 cushion in fabric T30 F102
MADRAS rug in Beige colour - SAN MARCO ceiling lamps with Rigadin and artistic shaded glass in Pesca colour



Standard

Design: Paolo Cattelan

Tavolino in cristallo curvato bronzo. Le misure del piano sono da considerare indicative.

Coffee table in curved bronze glass. Top dimensions are indicative.

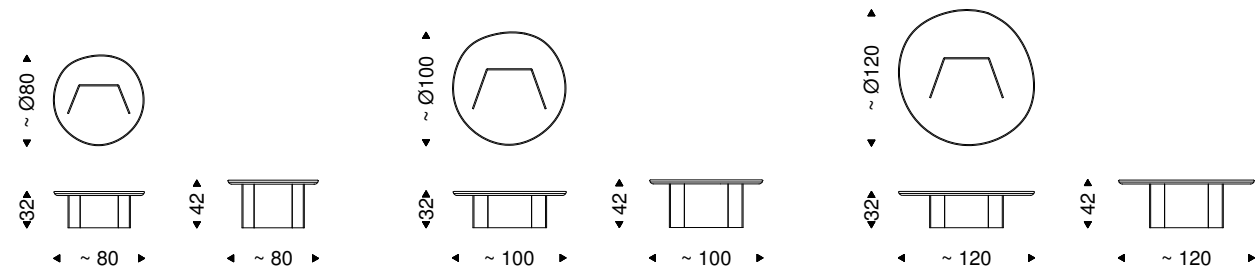

120



Standard



121



122

123

STANDARD coffee tables - BALDWIN sofa composition MIX with A part in fabric B206 and B part in glove soft leather GLW07 Argo - BLISS 55x55 cushions in fabric T30 F102 - BLISS 45x45 cushions in fabrics D186 and B206
BLISS 55x30 cushion in glove soft leather GLW07 - STEP side table in Brushed Brass - RADJA rug - CHELSEA sideboard in Mint with bronze mirrored glass top

Lagoon

Design: Studio Kronos

Tavolino con piano in vetro cotto bronzo. Piedi in noce Canaletto o frassino tinto rovere bruciato e telaio in acciaio verniciato gofrato bronzo. Le misure del piano sono da considerare indicative.

Coffee table with bronze textured glass top. Legs in Canaletto walnut or burned oak stained ashwood and frame in bronze embossed lacquered steel. Top dimensions are indicative.

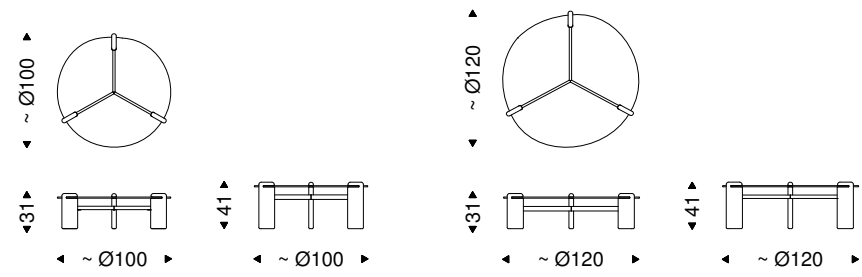

124



LAGOON coffee tables with burned oak base

Lagoon



125

LAGOON coffee tables with Canaletto walnut base - SENDAI rug



126

127

Bishop

Design: Lorenzo Remedi

Tavolino in ceramica artistica smaltata nei colori Cobalto, Etrusco o Smeraldo.

Artistic glazed ceramic side table available in Cobalto, Etrusco, or Smeraldo colors.

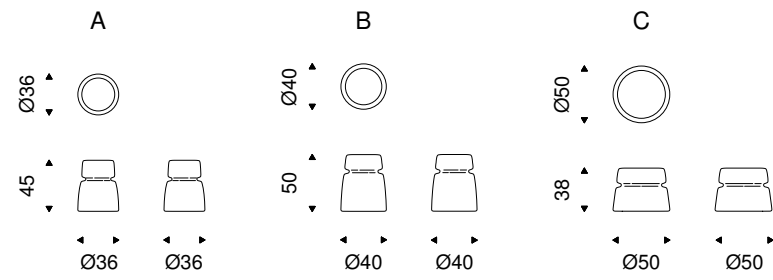

BISHOP side tables in Cobalto, Smeraldo and Etrusco colours

Bishop



BISHOP side tables in Etrusco colour - PEGGY TURN swivelling armchair in Nabuk soft leather P03 NK51 - RADJA rug - LATITUDE bookcases in embossed bronze



Amalfi

Design: Paolo Cattelan

Tavolino con base e colonna in acciaio verniciato gofrato titanio o bronzo o con base in acciaio verniciato gofrato bronzo e colonna in acciaio verniciato Brushed Bronze. Piano in ceramica Marmi nei colori Alabastro, Golden Calacatta opaco, Golden Calacatta lucido, Portoro opaco, Portoro lucido, Sahara Noir lucido, Makalu, Breccia, Corcovado, Kaindy, Borghini Calacatta opaco, Borghini Calacatta lucido, Colosseo, Andromeda, Invisible opaco, Taj Mahal, Giava, Darwin o Luxor.

Coffee table with base and column in titanium or bronze embossed lacquered steel or with base in bronze embossed lacquered steel and column in Brushed Bronze. Top in ceramic Marmi Alabastro, matt Golden Calacatta, glossy Golden Calacatta, matt Portoro, glossy Portoro, glossy Sahara Noir, Makalu, Breccia, Corcovado, Kaindy, matt Borghini Calacatta, glossy Borghini Calacatta, Colosseo, Andromeda, matt Invisible, Taj Mahal, Giava, Darwin or Luxor.

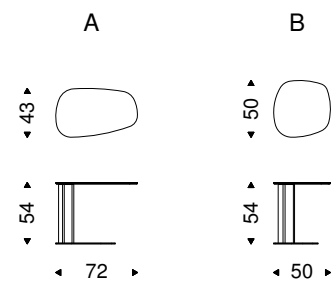

AMALFI side tables with embossed titanium base and column, and matt Borghini Calacatta ceramic top



AMALFI side tables with embossed bronze base, Brushed Bronze column and Corcovado ceramic top - GIBSON sofa in fabric T80 B096 - BLISS 45x45 cushions in fabrics T70 B132 - MADRAS rug in Ivory colour



AMALFI B side table with embossed bronze base, Brushed Bronze column and Corcovado ceramic top - GIBSON sofa in fabric T80 B096 - MADRAS rug in Ivory colour

Felix

Design: Studio Kronos

Carrello bar su ruote con struttura verniciata gofrato titanio o bronzo, ripiani in ceramica Marmi nei colori Alabastro, Portoro opaco, Portoro lucido, Makalu, Breccia, Corcovado, Kaindy, Colosseo, Taj Mahal o Giava.

Trolley bar on wheels with titanium or bronze lacquered frame. Tops in ceramic Marmi Alabastro, matt Portoro, glossy Portoro, Makalu, Breccia, Corcovado, Kaindy, Colosseo, Taj Mahal or Giava ceramic.

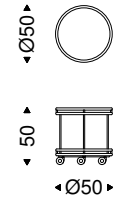

FELIX trolley bar with embossed bronze base and Corcovado ceramic top

Felix



FELIX trolley bar with embossed titanium base and Giava ceramic top - MURPHY sofa in fabric T20 D113 - COMFY 45x45 cushion in fabric T80 F021 - SENDAI rug

Peninsula

Design: Studio Kronos

Consolle in acciaio verniciato gofrato titanio, bronzo, Oxybrass o Oxygrey. Optional gancio portaborse per versione B. Fissaggio a parete necessario.

Console in embossed lacquered titanium, bronze, Oxybrass or Oxygrey steel. Optional purse hook B version. Wall anchorage is necessary.

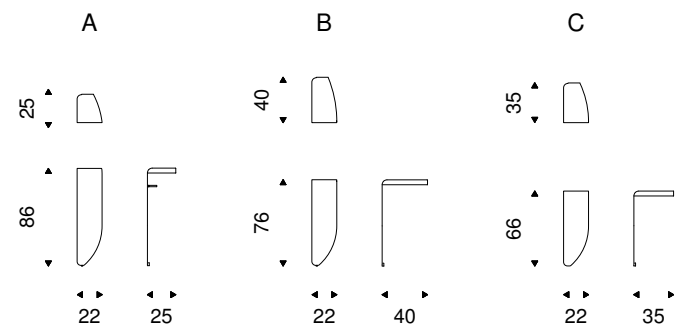

PENINSULA consoles in Oxybrass - HAWAII mirror in bronze mirrored glass

Brio Keramik

Design: Giorgio Cattelan

Consolle con struttura in acciaio verniciato gofrato titanio o bronzo e particolari in ottone. Piano in ceramica Marmi nei colori Portoro opaco, Portoro lucido, Makalu, Breccia, Kaindy, Colosseo, Taj Mahal o Giava.

Console with structure in titanium or bronze embossed lacquered steel and brass details. Marmi ceramic matt Portoro, glossy Portoro, Makalu, Breccia, Kaindy, Colosseo, Taj Mahal or Giava top.

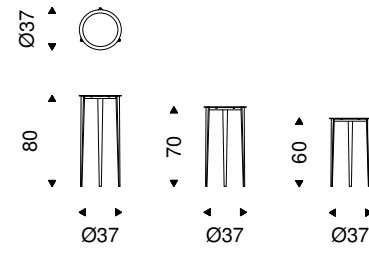

BRIO KERAMIK consoles with embossed titanium base and Makalu ceramic top - WISH mirror in Brushed Bronze

Chelsea

Design: Alessio Bassan

Madia contenitore in legno laccato titanio, Paprika o Mint. Top in cristallo specchiato bronzo o in ceramica Marmi nei colori Colosseo o Taj Mahal. Ripiani interni in cristallo trasparente. Versioni B con base in acciaio cromato o verniciato graphite.

Sideboard in titanium, Paprika or Mint lacquered wood. Top in bronze mirrored glass or ceramic Marmi Colosseo or Taj Mahal. Internal clear glass shelves. B version with chrome steel base or matt graphite varnished.

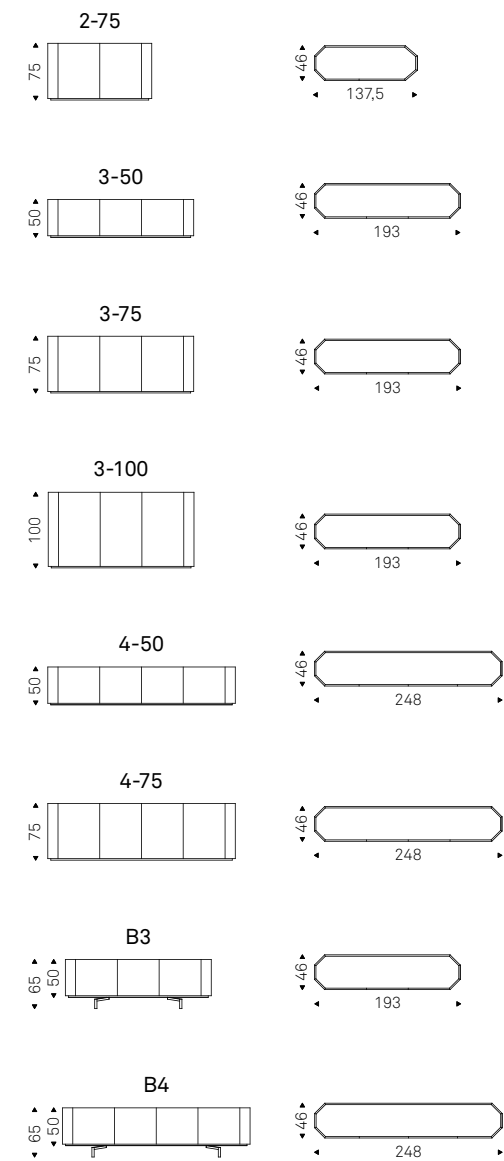

CHELSEA sideboard in Mint and Taj Mahal ceramic top - ASCOT MAGNUM mirror in bronze mirrored glass - SCARLETT chairs in glove soft leather GLV18 Barrique and embossed titanium frame - RADJA rug

Chelsea Drawers

Design: Alessio Bassan

Madia con cassetti in legno laccato titanio. Top in cristallo specchiato bronzo o in ceramica Marmi nei colori Colosseo o Taj Mahal.

Sideboard with drawers in titanium lacquered wood. Top in ceramic Marmi Colosseo, Taj Mahal or bronze mirrored glass.

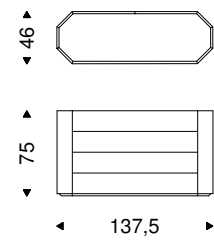

Chelsea Drawers



CHELSEA DRAWERS sideboard in titanium with bronze mirrored glass top - SENDAI rug

Address

Design: Paolo Cattelan

Libreria componibile con fissaggio a muro o a soffitto. Struttura in acciaio verniciato goffrato titanio con particolari in Oxygrey o bronzo con particolari in Oxybrass e ripiani in legno noce Canaletto con il fondo verniciato goffrato titanio o rovere bruciato con il fondo verniciato goffrato bronzo. Portata massima per ripiano 4 Kg.

Modular wall- or ceiling-hanging bookcase with frame in titanium embossed lacquered steel with Oxygrey details or in bronze with Oxybrass details and shelves in Canaletto walnut with lower part in titanium embossed lacquered wood or in burned oak with lower part in bronze embossed lacquered wood. Max capacity: each shelf kg 4.

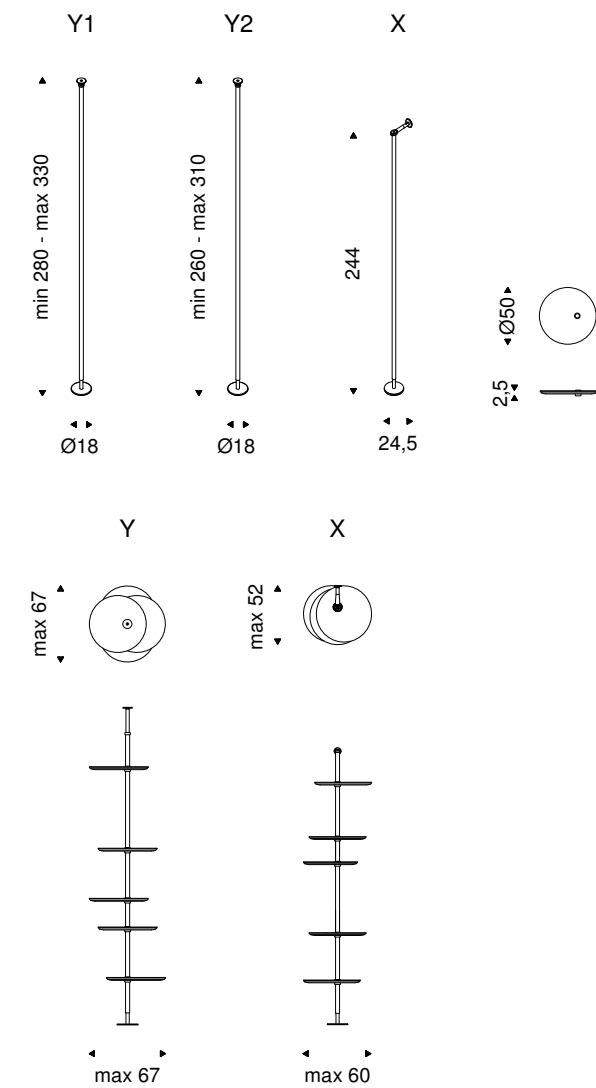

ADDRESS bookcase in burned oak and embossed bronze frame - ADDRESS bookcase in Canaletto walnut and embossed titanium frame



ADDRESS bookcases in Canaletto walnut and embossed titanium frame - PEGGY TURN swivelling armchair in Nabuk soft leather P03 NK57 - KIMI rug in White colour
BOSTON B desk with top in burned oak and insert in leather 21 Oliva



Address

“

Concepita come sistema modulare, Address si sviluppa a 360 gradi per una collocazione a centro stanza. I ripiani arrotondati, da posizionare liberamente, rievocano le foglie di una pianta rampicante in dialogo con l'ambiente.

Designed as a modular system, Address rotates 360 degrees, making it a dynamic centerpiece for any room. The rounded shelves, which can be positioned freely, evoke the leaves of a climbing plant, establishing a harmonious dialogue with the surrounding environment.



149

▲ ADDRESS bookcase in burned oak and embossed bronze frame
◀ ADDRESS bookcases in Canaletto walnut and embossed titanium frame

San Marco

Design: Studio Kronos

Lampada a soffitto con paralume in vetro artistico decorato sfumato o Rigadin nei colori Verde o Pesca. Attacco a soffitto in acciaio cromo nero. Illuminazione a led. Disponibile nella versione luce fissa con possibilità di dimmerazione attraverso gli optional telecomando e ricevitore oppure dimmerabile per sistemi DALI / PUSH / 1-10V / 0-10V.

Ceiling lamp with lampshade in artistic shaded or Rigadin glass, available in green or peach color. Ceiling plate in black chrome steel. Led lights. Available in the continuous light version with optional remote control and receiver to dim the light or dimmable for DALI / PUSH / 1-10V / 0-10V systems.

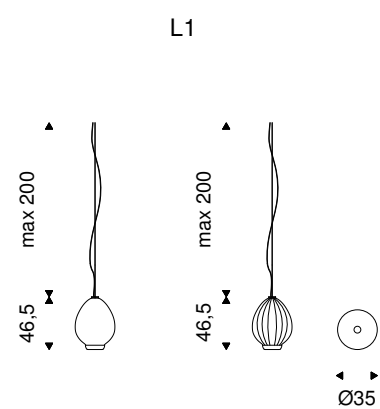
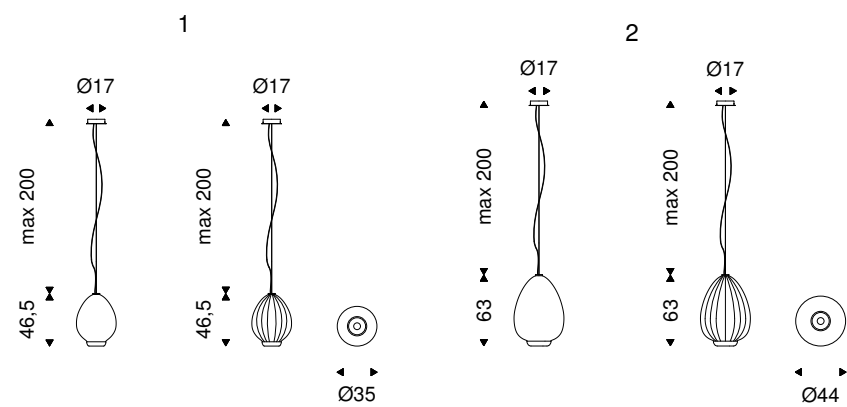

Socket 2/6





SAN MARCO ceiling lamps with Rigadin and artistic shaded glass in Verde colour - SENATOR KERAMIK MAGNUM 4.0 table with embossed titanium base and matt Borghini Calacatta ceramic top
BRITNEY TURN swivelling armchair in fabric B206

Wanted

Design: STC Studio

Piantana con struttura in acciaio verniciato gofrato nero. Paralumi in vetro artistico Balloton verde Pavone, Ambra o Madreperla. Illuminazione a led dimmerabile con pedaliera.

Floor lamp with frame in black embossed lacquered steel. Lampshades in artistic decorated Verde Pavone, Ambra or Madreperla Balloton glass. Dimmable led light with footswitch.

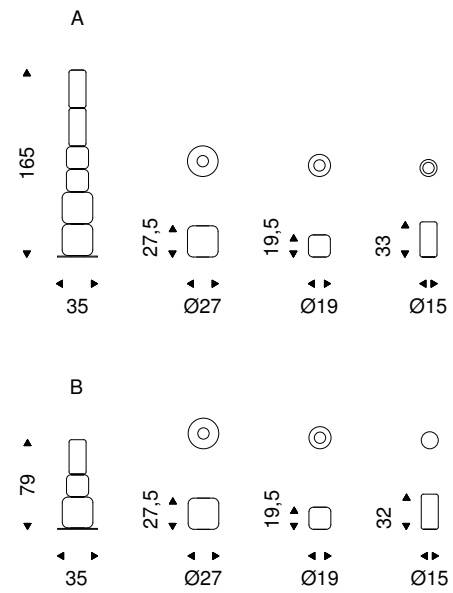

WANTED B floor lamp in Madreperla colour - STING BRUSHED side table in Brushed Bronze - MAPOON rugs

“

Nella versione piantana, Wanted si distingue per il cristallo dalle tonalità turchesi e opaline. Un effetto ispirato alle superfici ghiacciate, che si ottiene dalla tradizionale lavorazione “balloton” del vetro fuso, riconoscibile nel pattern a rombi incrociati.

In its floor-standing version, Wanted stands out for its glass featuring turquoise and opaline tones. Inspired by icy surfaces, this effect is achieved through the traditional “balloton” glassmaking technique, recognizable in its signature crosshatched diamond pattern.



Potter

Design: Andrea Marangoni

Lampada da tavolo con base in alluminio Pink Champagne. Paralume in vetro artistico. Lampadina non inclusa.

Table lamp with base in Pink Champagne aluminium. Lampshade in artistic glass. Bulb not included.

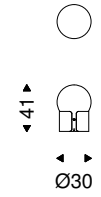

Potter



POTTER table lamp - AMSTERDAM sideboard - GLENN mirror in bronze mirrored glass

Pierre

Design: Tosca Design

Specchio servomuto con base in frassino tinto noce Canaletto o frassino tinto rovere bruciato e struttura in acciaio verniciato gofrato bronzo. Specchio in cristallo specchiato.

Valet mirror with Canaletto walnut stained ashwood or burned oak stained ashwood base. Structure in bronze embossed lacquered steel. Mirror in mirrored glass.

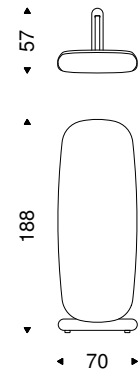

Pierre



PIERRE valet mirror in burned oak - RICHARD bed in fabric T30 D108 - PEYOTE side table with titanium base and bronze mirrored glass top - MADRAS rug in Beige colour
CHELSEA DRAWERS sideboard in titanium with bronze mirrored glass top

Richard

Design: Studio 28

Letto imbottito rivestito in tessuto, micro nubuck, ecopelle o pelle come da campionario. Rete inclusa. Optional: rete alzabile con vano contenitore.

Upholstered bed covered in fabric, micro nubuck, synthetic leather or soft leather as per sample card. Slats included. Optional: pull-up slats with container.

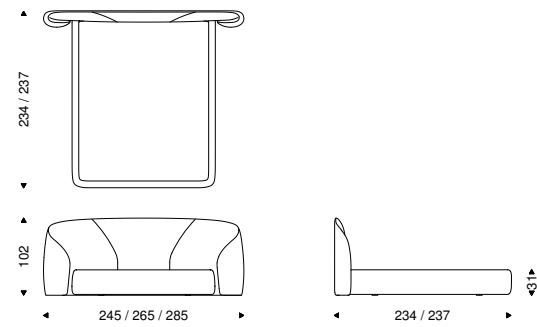

RICHARD bed in fabric T30 D108 - PEYOTE side table with titanium base and bronze mirrored glass top



164

165

Elias

Design: Studio 28

Comodino con struttura in legno laccato titanio o Beige lucido e anta rivestita in pelle come da campionario. Maniglia in tinta con la struttura.

Nightstand with structure in titanium lacquered wood or glossy Beige lacquered wood, and door upholstered in soft leather as per sample card. Handle finished to match the frame color.

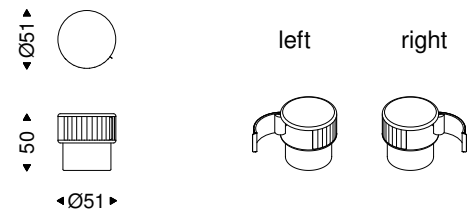

Elias



ELIAS nightstand with lacquered glossy Beige and soft leather 951 Castoro door - RICHARD bed in fabric T30 D108

Kiran

Design: Studio Kronos

Tappeto tessuto in cotone, poliestere ed acrilico con disegno in rilievo in lana, nei colori Etrusco o Tortora.

Rug made of cotton, polyester and acrylic with relief design in wool, in colours Etrusco or Tortora.

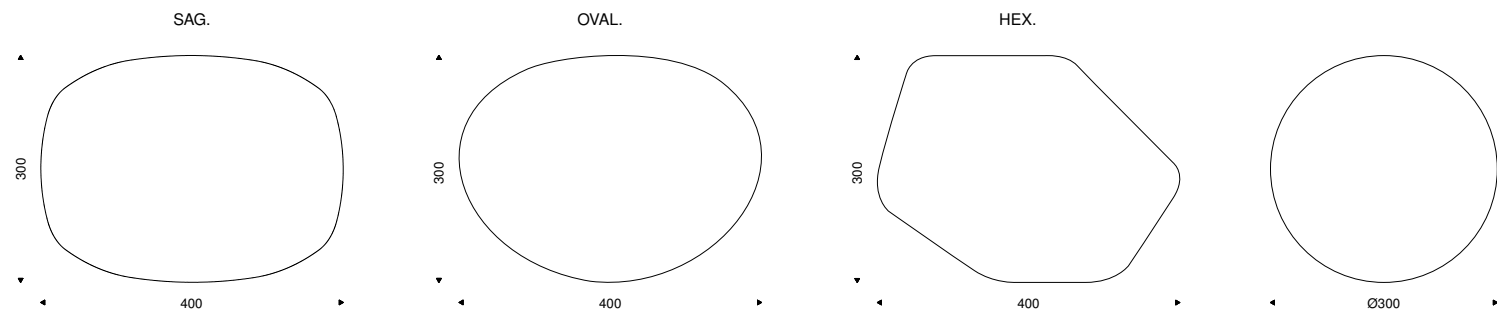

KIRAN rug oval. in Tortora colour

Kiran



KIRAN rug oval. in Tortora colour - PEYOTE side tables with titanium base and bronze mirrored glass top



“

I motivi geometrici, con le loro forme sovrapposte, evocano il fascino esotico delle decorazioni indiane tipiche dei tessuti e delle architetture tradizionali. Il pattern in leggero rilievo, dai colori caldi a contrasto, ne rafforza l'armonia visiva.

Its geometric motifs, with overlapping shapes, recall the exotic charm of traditional Indian ornamentation, inspired by both textile artistry and architectural heritage. The softly raised pattern, defined by warm contrasting tones, enhances its visual harmony and sophisticated sense of balance.

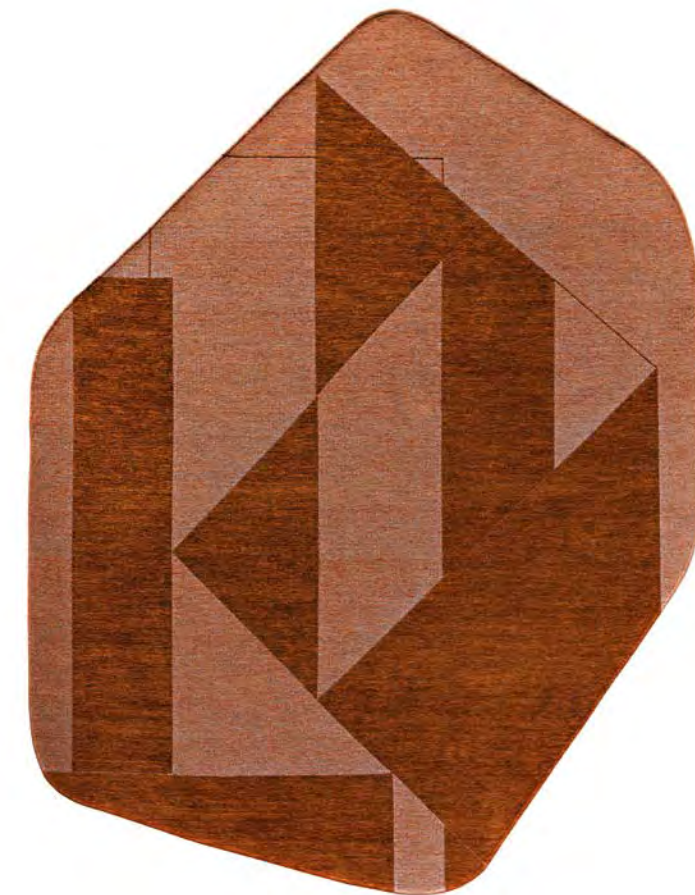

Nuove Finiture / New Finishes

Ceramiche

Ceramics



Boomerang top in KM28 Darwin ceramic



Boomerang top in KM26 Taj Mahal ceramic



Boomerang top in KM27 Giava ceramic

Finiture / Finishes

Marmi

Marbles



Lepanto



Avocatus



Onda Grigia

Tessuti Divani

Sofa Fabrics



B205



D185



D189



B192



B194



B198



B199

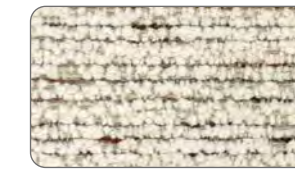

D186



B195



B204

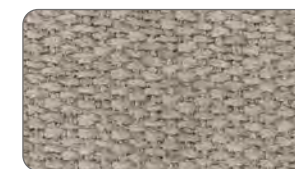

B193



B200

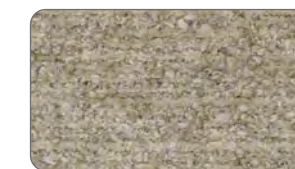

B206



B207

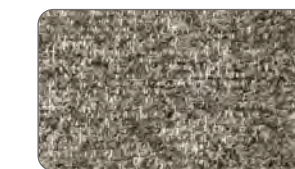

B201



D191



B208



D190



B196

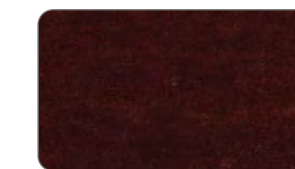

B197

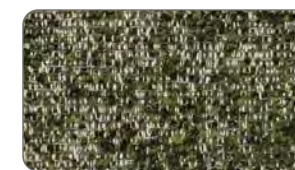

B202

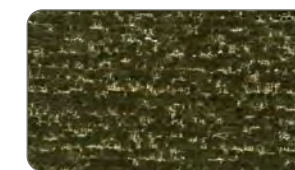

D187

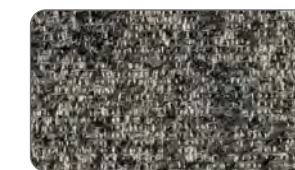

B203



D188

Legno Laccato

Lacquered Wood



M75 Mint

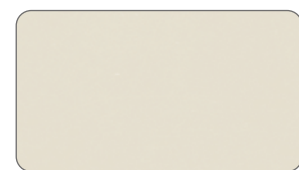

L9 Beige

Pelli

Soft Leathers



*GLV22 / GLW22
Botanico*

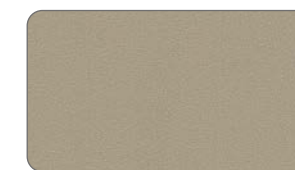

*GLV21 / GLW21
Juta*



*GLV20 / GLW20
Senape*



*GLV23 / GLW23
Amarone*

Cattelan Italia spa

via Pilastrì 19

36010 Carrè (VI) Italy

t +39 0445 318711

f +39 0445 314289

info@cattelanitalia.com

cattelanitalia.com



Cattelan Italia spa si riserva di apportare, senza preavviso, modifiche nei materiali, nei rivestimenti, nelle finiture e nei disegni dei prodotti presentati in questo catalogo. Le texture ed i colori dei materiali e delle finiture hanno valore indicativo in quanto soggetti alle tolleranze dei processi di stampa.

Cattelan Italia spa reserves the right to change, without previous notice, materials, covers, finishes and drawings of the products presented in this catalogue. The textures and colours of materials and finishes are indicative as they are depending on the tolerances of the printing process.

Cattelan Italia spa se réserve le droit d'apporter, sans préavis, des modifications au niveau des matériaux, des revêtements, des finitions et du design des produits présentés dans ce catalogue. Les textures et les couleurs des matériaux et des finitions sont une valeur indicative parce-que ils changent selon la tolérance aux procédés d'imprimerie.

Cattelan Italia spa behält sich vor, ohne Vorankündigung, Veränderungen an den Materialien, Bezügen, Ausführungen und Zeichnungen der in diesem Katalog vorgestellten Produkte vorzunehmen. Die Texturen und Farben der Materialien und Finish haben einen hinweisenden Wert, da sie von den Toleranzen im Druckprozess abhängig sind.

Cattelan Italia spa se reserva el derecho de aportar modificaciones de dibujo, materiales, acabados y tapicerías, sin que esté obligada a dar aviso anticipado. Las texturas y los colores de los materiales y de los acabados tienen solo un valor indicativo porque están sujetos a la tolerancia en los procesos de imprenta.

Cattelan Italia spa оставляет за собой право без предварительного уведомления вносить изменения в материалы, покрытия, обивку и дизайн продуктов, представленных в этом каталоге. Текстуры и цвета материалов являются ориентировочными, поскольку их точность зависит от различных факторов в процессе печати каталогов.

Cattelan Italia spa保留对目录中产品的材料、覆面、饰面和图纸更改的权利，恕不另行通知。因样板制作或印刷存在误差，样板的纹理和颜色仅提供参考。

Art Direction

Cattelan Italia Lab

Book 2026 Collection



Book 1
Dining Tables

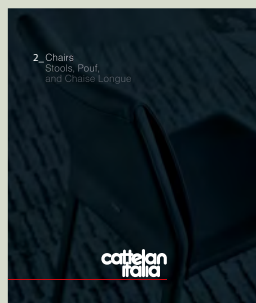

Book 2
Chairs
Stools, Pouf
and Chaise Longue



Book 3
Sideboards
Bookcases, Shelves
TV units and Showcases



Book 4
Desks, Consoles
Coffee Tables, Mirrors
Rugs and Complements

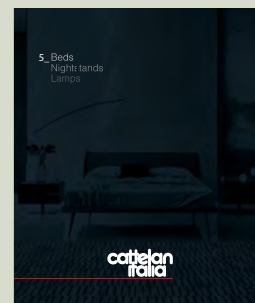

Book 5
Beds
Nightstands
Lamps

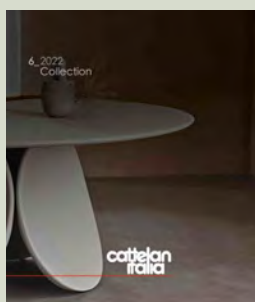

Book 6
2022 Collection

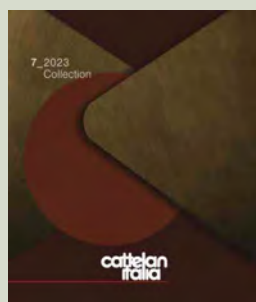

Book 7
2023 Collection



Book 8
2024 Collection



Book 9
2025 Collection



Book 10
2026 Preview Collection

**cattelan
italia**

cattelanitalia.com