

Zanziball 2/6

design

cattelan italia

11



24V

Output 24V - Connect
Positive: V+ to Red Cable
Negative: V- to Black Cable

2



13

4



7

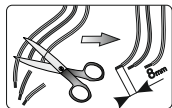

6



8



3



Input 110-240
50/60Hz

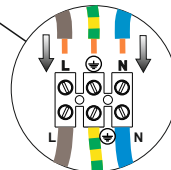

12

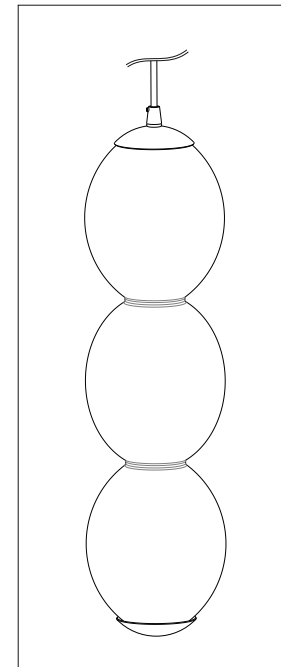

5

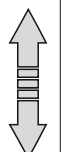

14



9

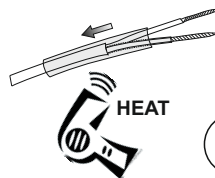
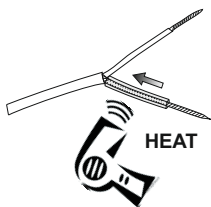

A

B

C

10

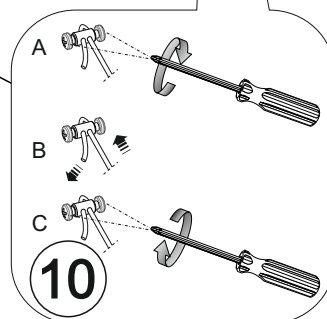

1

