

CHELSEA

design Alessio Bassan - 2010

cattelan
italia



ISTRUZIONI DI MONTAGGIO - ASSEMBLING INSTRUCTIONS - MONTAGEANLEITUNG
INSTRUCTIONS DE MONTAGE - INSTRUCCIONES DE MONTAJE
ИНСТРУКЦИИ ПО МОНТАЖУ - 安装指导 - تعليمات التجميع

Cattelan Italia spa si riserva di apportare, senza preavviso, modifiche nei materiali, nei rivestimenti, nelle finiture e nei disegni dei prodotti. Le textures ed i colori dei materiali e delle finiture hanno valore indicativo in quanto soggetti alle tolleranze dei processi di stampa.

Cattelan Italia spa reserves the right to change, without previous notice, materials, covers, finishes and drawings of the products. The textures and colours of materials and finishes are indicative as they are depending on the tolerances of the printing process.

Cattelan Italia spa behaltet sich vor, ohne Vorankündigung, Veränderungen an den Materialien, Bezügen, Finish und Zeichnungen Produkte vorzunehmen. Die Texturen und Farben der Materialien und Finish haben einen hinweisenden Wert, da sie von den Toleranzen im Druckprozess abhängig sind.

Cattelan Italia spa se réserve le droit d'apporter, sans préavis, des modification au niveau des matériaux, des revêtements, des finitions et du design des produits. Les textures et les couleurs des matériaux et des finitions sont une valeurs indicative parce-que ils changent selon la tolérance aux procédés d'imprimerie.

Cattelan Italia spa se reserva el derecho de aportar modificaciones de dibujo, materiales, acabados y tapicerias, sin que esté obligada a dar aviso antipado. Las textures y los colores de los materiales y de los acabados tienen solo un valor indicativo porque estan sujetos a la tolerancia en los procesos de imprenta.

Cattelan Italia spa оставляет за собой право делать изменения, без предупреждения, в материалах, обивках, отделках и в чертежах продуктов, которые представлены в данном каталоге. Текстуры и цвета материалов и отделок в каталоге не передают реальные цвета предметов, из-за особенности процессов печати и цветопередачи.

Cattelan Italia

公司保留变更图册中材料、包覆材质、饰面、图像的权利，无须事先通知。因印刷等工艺存在偏差，材料和饰面等的纹理和颜色仅供参考。

تحتفظ شركة Cattelan Italia SPA بالحق في تغيير المواد والأغطية والتشطيبات والرسومات الخاصة بالمنتجات دون إشعار مسبق. تعتبر قوام وألوان المواد والتشطيبات إرشادية لأنها تعتمد على تفاوتات عملية الطباعة.

IMPORTANT: Riporre per eventuali consultazioni future.

IMPORTANT: File for future consultation.

WICHTIG: Bitte aufbewahren für eventuelle spätere Nachfragen.

IMPORTANT: A conserver pour les futurs besoins de reference.

IMPORTANTE: Guardar para consultas posteriores.

ВАЖНО: Сохранить для возможной будущей консультации.

重要事项：存档以备日后咨询

هام: ملف للتشاور في المستقبل.

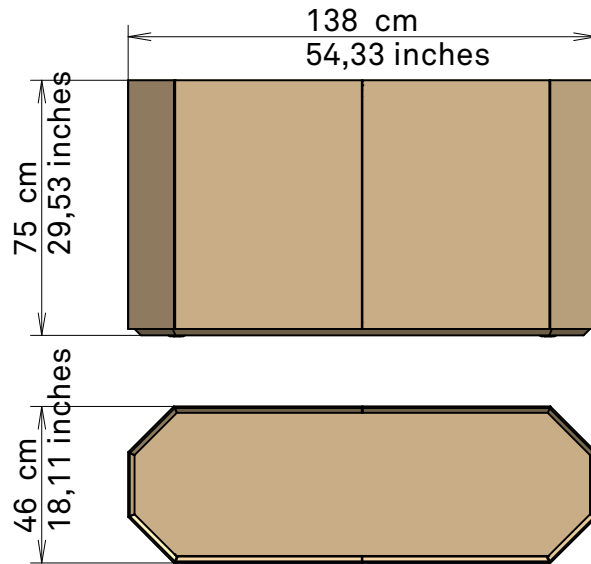

2-75

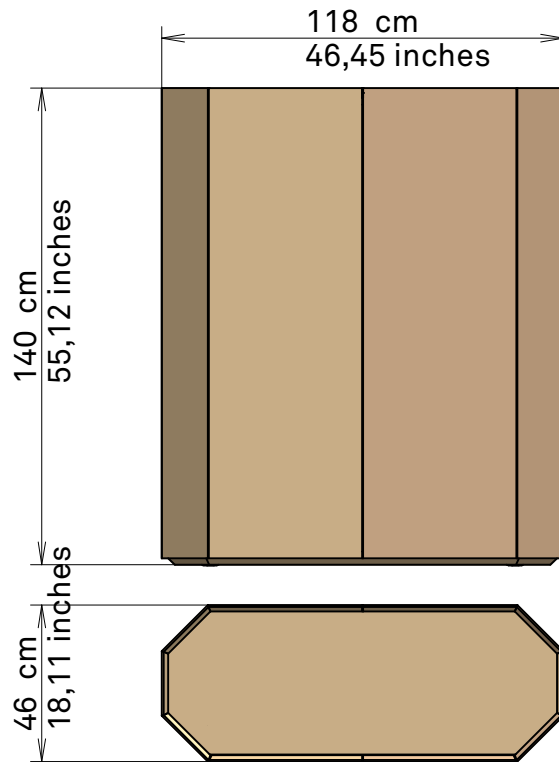

2-140

n° 12 pz.



n° 04 cod. 216420900600 2-75.
n° 04 cod. 216420900600 2-140.

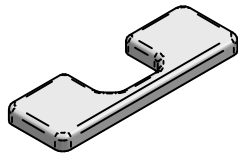

n° 04 cod. 216420900700 2-75.
n° 04 cod. 216420900700 2-140.



n° 08 adesivo ø13.



n° 15 pz ø12x1 trasparente.



n° 01 da 04.

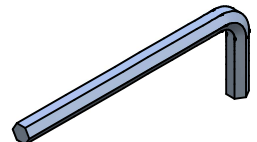

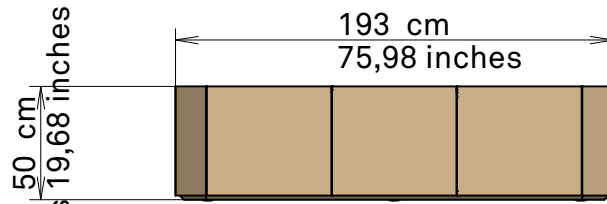

3-50

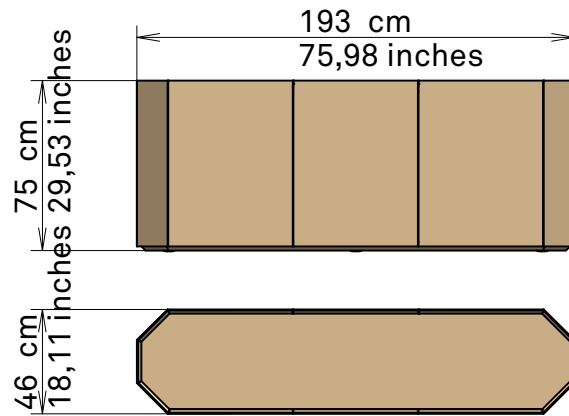

3-75

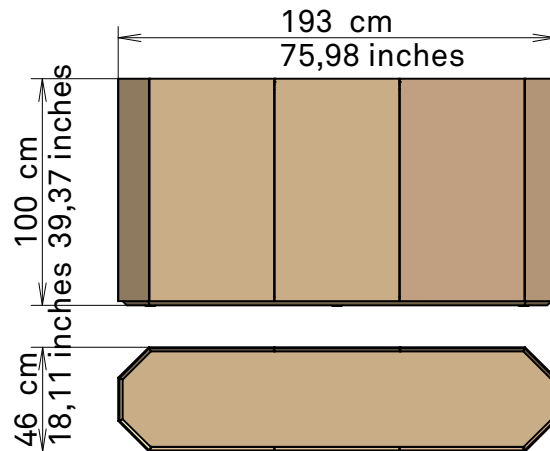

3-100



n° 18 pz.



n° 06 cod. 216420900600.

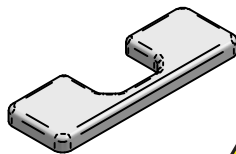

n° 06 cod. 216420900700.

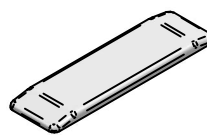

n° 08 adesivo ø13.



n° 15 pz ø12x1 trasparente.



n° 01 da 04.

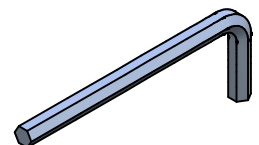

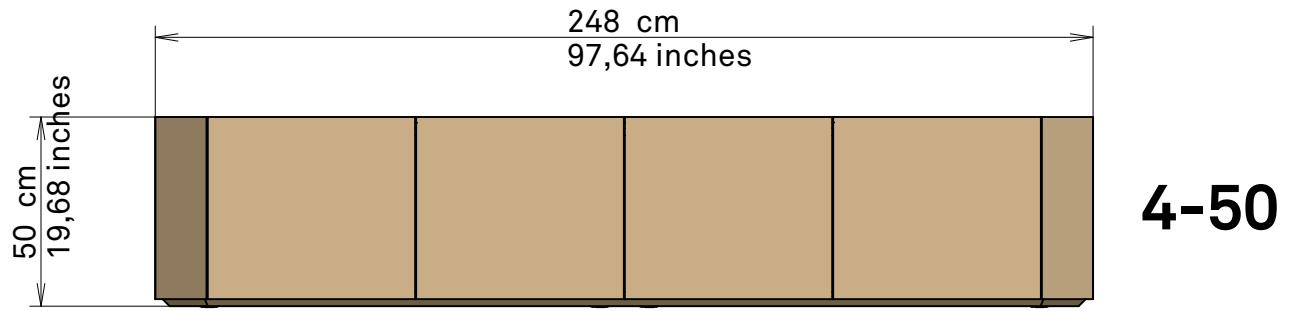

4-50

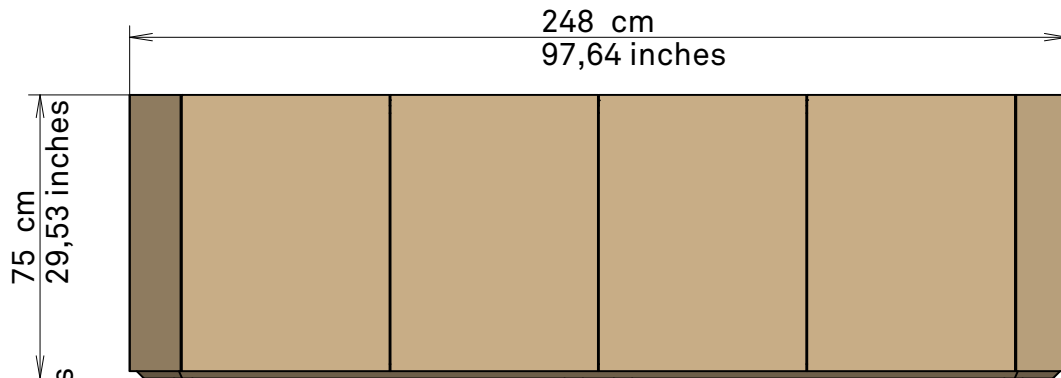
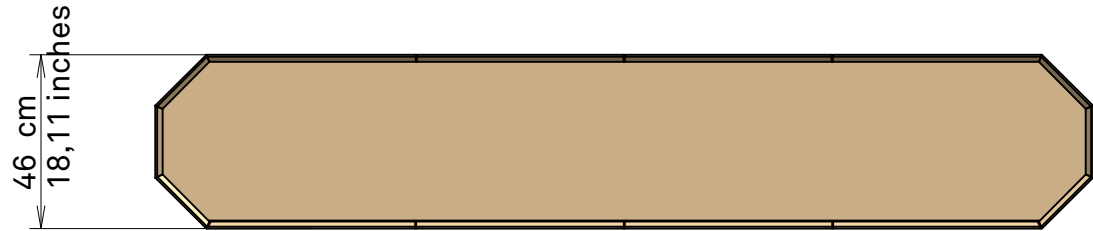

4-75

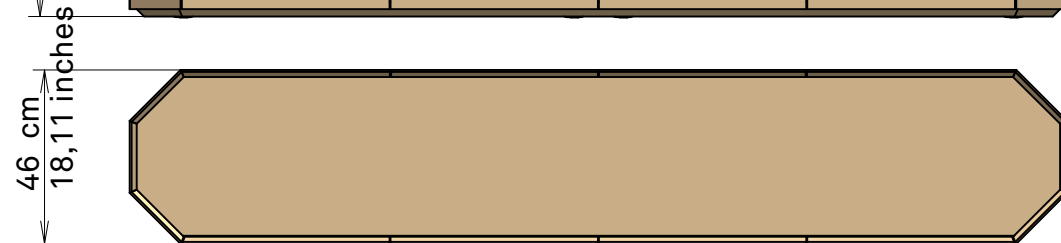

n° 18 pz.



n° 08 cod. 216420900600.

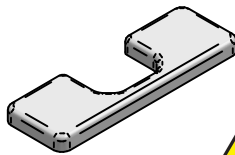

n° 08 cod. 216420900700.

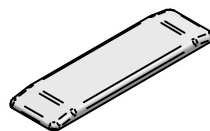

n° 08 adesivo ø13.



n° 15 pz ø12x1 trasparente.



n° 01 da 04.

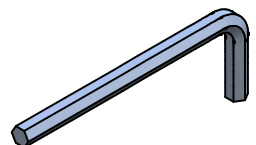

2-75

n° 08 pz reggipiano.

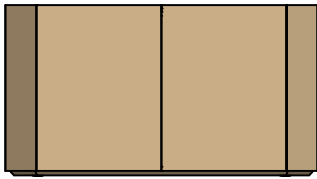

2-140

n° 12 pz reggipiano.

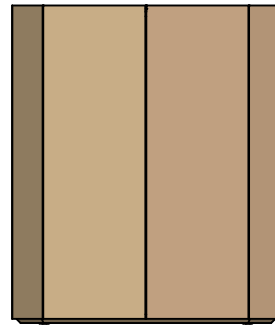

3-50

n° 08 pz reggipiano.



3-75

n° 16 pz reggipiano.

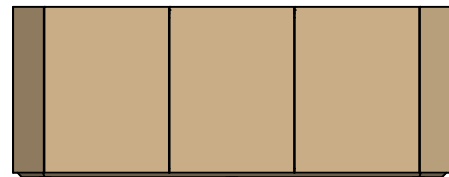

3-100

n° 16 pz reggipiano.

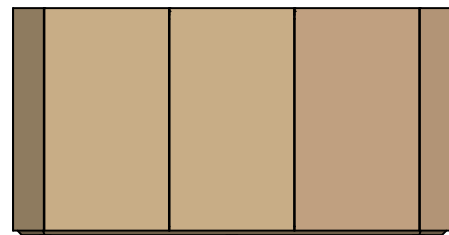

4-50

n° 08 pz reggipiano.



4-75

n° 16 pz reggipiano.

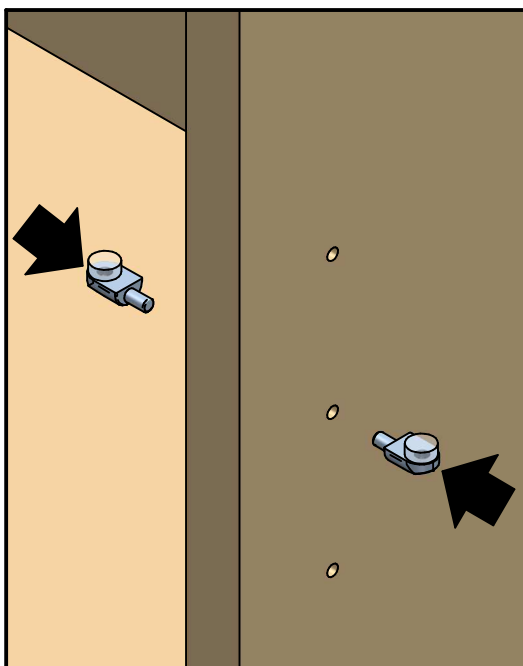
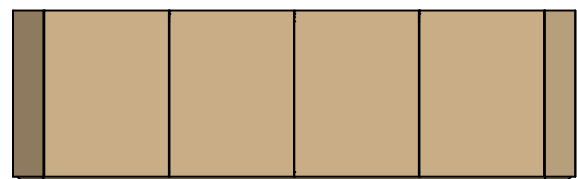

n° 18 pz.



PORTATA:
 WEIGHY CARRYING CAPACITY :
 BELASTUNG:
 PORTEE:
 PORTADA:
 Максимально допустимая нагрузка:
 承载力:

x1 12 Kg MAX

2-140

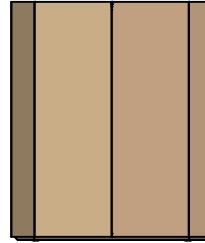

ATTENZIONE!
 ATTENTION!
 ACHTUNG!
 ATTENTION!
 ¡ATENCIÓN!
 ВНИМАНИЕ
 注意

2-75

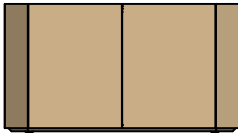

3-75

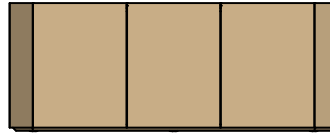

3-50



3-100

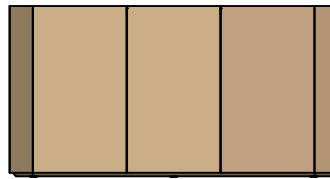

4-50



4-75



Regolazioni
 Adjustments
 Einstellung
 Réglages
 Regulaciones
 Регулировка
 调节项

ESSENZIALE
 ESSENTIAL
 NOTWENDIG
 ESSENTIEL
 ¡ESENCIAL!
 Важно
 重要

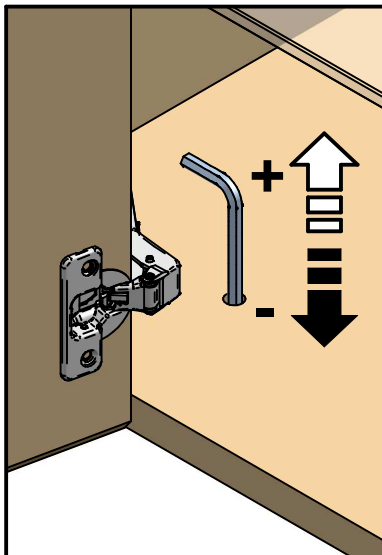
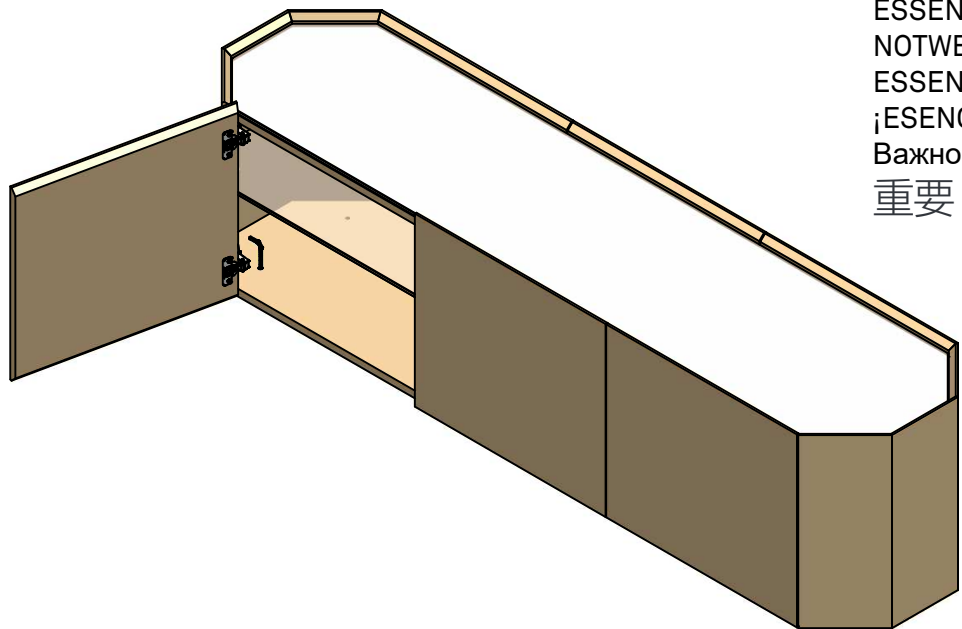

n° 01 da 04.

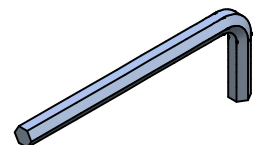

Regolazioni
Adjustments
Einstellung
Réglages
Regulaciones
Регулировка
调节项

ESSENZIALE
ESSENTIAL
NOTWENDIG
ESSENTIEL
¡ESENCIAL!
Важно
重要

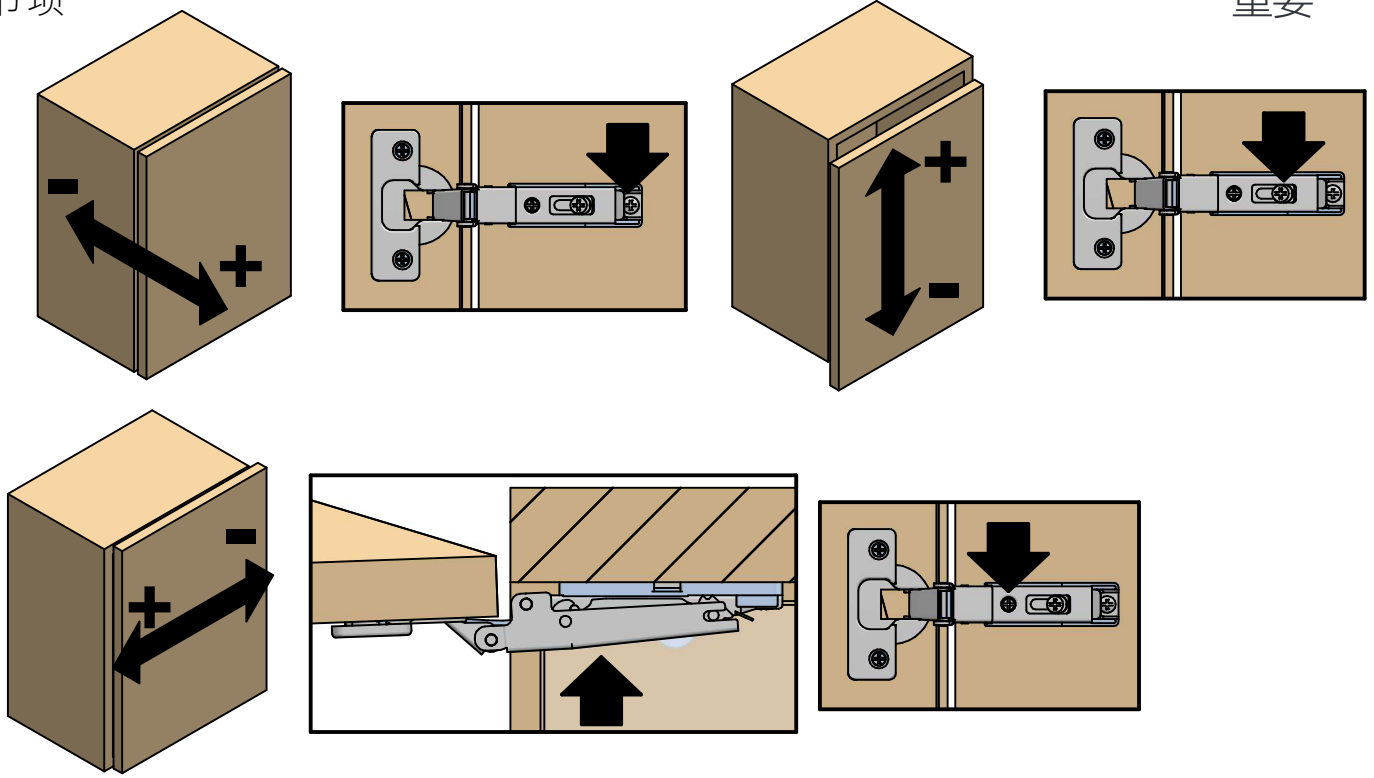

ATTENZIONE!
ATTENTION!
ACHTUNG!
ATTENTION!
¡ATENCIÓN!
ВНИМАНИЕ
注意

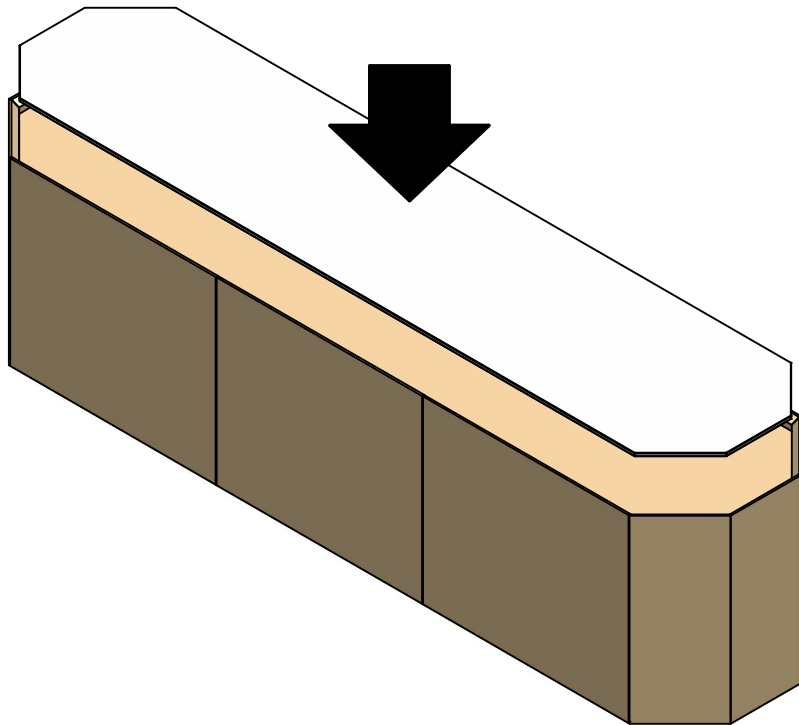

Il prodotto è destinato per l'utilizzo all'interno delle abitazioni con l'uso per il quale è stato realizzato.

REALIZZAZIONE

Piccole irregolarità sulla base sono dovute alla lavorazione manuale del prodotto.

SMALTIMENTO

Una volta dismesso, il prodotto od i suoi componenti non vanno dispersi nell'ambiente ma conferiti ai sistemi pubblici di smaltimento.

MANUTENZIONE

Non vanno assolutamente utilizzati strumenti metallici appuntiti o panni abrasivi per eliminare eventuali residui di sporco presenti sulla superficie del prodotto, in quanto possono danneggiare la superficie stessa. Non vanno assolutamente utilizzati detersivi che contengano cloro o a base di acido cloridrico, acido muriatico o prodotti anticalcare in quanto andrebbero ad alterare la brillantezza del prodotto.

USE

The product is intended for an indoor use and may only be used for its intended purpose.

ACCOMPLISHMENT

Small irregularities on the base are due to manual processing.

DISPOSAL

If your furniture is unusable or unrepairable, neither the product nor its components are to be dispersed in the environment, but rather consigned to public disposal systems.

MAINTENANCE

It is recommended not to use metal sharp tools or abrasive clothes to eliminate dirt from the surface, because they could damage the same. Do not absolutely use detergents containing chlorine, muriatic acid, hydrochloric acid or descale detergents which can damage the surface brilliance.

NUTZUNG

Das Produkt ist nur für den Innenbereich gedacht. Der Tisch wurde hergestellt, nur als Esstisch genutzt zu werden.

AUSFÜHRUNG

Kleine Unregelmäßigkeiten auf der Basis sind nicht zu vermeiden, da das Teil per Hand hergestellt wird.

ENTSORGUNG

Nach der Aussonderung ist das Produkt und seine Bestandteile nicht selbständig im Freien zu entsorgen, sondern der städtischen Müllabfuhr zu übergeben.

WARTUNG

Niemals scharfe Werkzeuge aus Metall, spitzen Instrumente oder Schleifmittel für die Reinigung der Oberfläche verwenden. Diese Produkte können die Oberfläche beschädigen. Niemals Chemikalien mit chlorhaltigen Salzsäure, Salzsäure oder Kalk-Produkte für die Reinigung verwenden. Diese Produkte können der Glanz beschädigen.

FR UTILISATION

Le produit est destiné pour une utilisation à l'intérieur des habitations.

CONSTRUCTION

Les petites irrégularités sur la base sont dues à une fabrication manuelle.

ECOULEMENT

Une fois disloqué, le produit ou ses composants ne doivent pas être dispersés dans la nature mais confiés aux décharges publiques.

MANUTENTION

Il ne faut pas absolument utiliser des outils pointus ou des chiffons abrasifs pour éliminer des possibles restes sur la surface du produit, parce qu'ils peuvent endommager la surface même. Ne pas utiliser des détergents contenant du chlore, acide chlorhydrique, acide muriatique ou produits anticalcaire qui peuvent altérer le brillant du produit.

ES USO

El producto está destinado para su uso dentro del hogar, a los fines por los cuales fue creado.

CONSTRUCCIÓN

Pequeñas irregularidades en la base están causadas por la producción manual.

ELIMINACIÓN DE DESECHOS

Una vez desechado, el producto o sus componentes no se tienen que abandonar en el entorno sino entregar al sistema público de recogida de basuras.

MANTENIMIENTO

No utilizar en cualquier forma instrumentos de metal afilados o telas abrasivas para eliminar cualquier resto de suciedad en la superficie del producto, ya que pueden dañar la superficie misma. No utilizar en cualquier forma limpiadores a base de cloro o que contienen ácido clorhídrico, ácido muriático o productos anticalcáreos ya que pueden alterar el brillo del producto.

RU ИСПОЛЬЗОВАНИЕ

Изделие предназначено для использования внутри помещения.

РЕАЛИЗАЦИЯ

Небольшие неровности на основе связаны с обработкой изделия вручную.

УТИЛИЗАЦИЯ

После утилизации, продукт и его компоненты не должны разлагаться в окружающей среде, а должны быть переданы в специализированные места утилизации.

УХОД

Не используйте острые металлические инструменты или абразивные губки для удаления грязи, так как они могут повредить поверхности. Ни в коем случае не используйте моющие средства, содержащие хлор, соляную кислоту или средства от известкового налета, поскольку они могут повлиять на блеск предмета.

使用:

此产品仅限于室内使用，也只能按其用途使用。

注:

底座上的小的不规则处是手工加工产生的

警告:

请勿通过拖拽或是抬起桌面来移动产品，应将其放在要放的位置重新组装，以避免损坏产品部件。

处理方法:

如果家具不能使用或是不能修复，不要把产品及其部件散步在外面，应将其交由公共处置系统。

保养

不建议使用锋利的金属工具或磨料织物去除表面上的污垢，因为它们可能会损害产品。请勿使用含有氯林，盐酸，氢氯酸的洗涤剂或浓缩洗涤剂清理产品，因为它们会破坏产品表面的光泽。

**cattelan
italia**

CATTELAN ITALIA SPA
Via Pilastri, 19
36010 Carré (VI), Italy
Ph. +39 0445 318711
info@cattelanitalia.com
www.cattelanitalia.com

