



ISTRUZIONI DI MONTAGGIO - ASSEMBLING INSTRUCTIONS - MONTAGEANLEITUNG  
INSTRUCTIONS DE MONTAGE - INSTRUCCIONES DE MONTAJE  
ИНСТРУКЦИИ ПО МОНТАЖУ - 安装指导 - تعليمات التجميع

**IT** Cattelan Italia spa si riserva di apportare, senza preavviso, modifiche nei materiali, nei rivestimenti, nelle finiture e nei disegni dei prodotti. Le textures ed i colori dei materiali e delle finiture hanno valore indicativo in quanto soggetti alle tolleranze dei processi di stampa.

**Riporre per eventuali consultazioni future.**

**EN** Cattelan Italia spa reserves the right to change, without previous notice, materials, covers, finishes and drawings of the products. The textures and colours of materials and finishes are indicative as they are depending on the tolerances of the printing process.

**File for future consultation.**

**DE** Cattelan Italia spa behaltet sich vor, ohne Vorankündigung, Veränderungen an den Materialien, Bezügen, Finish und Zeichnungen Produkte vorzunehmen. Die Texturen und Farben der Materialien und Finish haben einen hinweisenden Wert, da sie von den Toleranzen im Druckprozess abhängig sind.

**Bitte aufbewahren für eventuelle spätere Nachfragen.**

**FR** Cattelan Italia spa se réserve le droit d'apporter, sans préavis, des modification au niveau des matériaux, des revêtements, des finitions et du design des produits. Les textures et les couleurs des matériaux et des finitions sont une valeurs indicative parce-que ils changent selon la tolérance aux procédés d'imprimerie.

**A conserver pour les futurs besoins de reference.**

**ES** Cattelan Italia spa se reserva el derecho de aportar modificaciones de dibujo, materiales, acabados y tapicerías, sin que esté obligada a dar aviso antipado. Las textures y los colores de los materiales y de los acabados tienen solo un valor indicativo porque estan sujetos a la tolerancia en los procesos de imprenta.

**Guardar para consultas posteriores.**

**RU** Cattelan Italia spa оставляет за собой право делать изменения, без предупреждения, в материалах, обивках, отделках и в чертежах продуктов, которые представлены в данном каталоге. Текстуры и цвета материалов и отделок в каталоге не передают реальные цвета предметов, из-за особенности процессов печати и цветопередачи.

**Сохранить для возможной будущей консультации.**

**CN** Cattelan Italia

公司保留变更图册中材料、包覆材质、饰面、图像的权利，无须事先通知。因印刷等工艺存在偏差，材料和饰面等的纹理和颜色仅供参考。  
重要事项：存档以备日后咨询

**AR** تحتفظ شركة Cattelan Italia SPA بالحق في تغيير المواد والأغطية والتشطيبات والرسومات الخاصة بالمنتجات دون إشعار مسبق.

تعتبر قوام وألوان المواد والتشطيبات إرشادية لأنها تعتمد على تفاوتات عملية الطباعة.







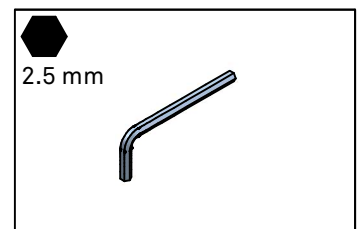
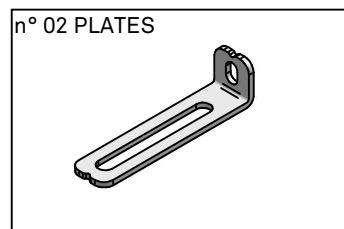
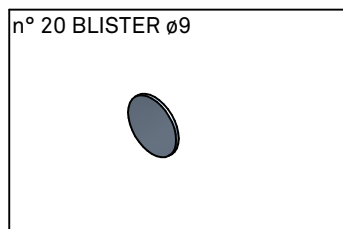
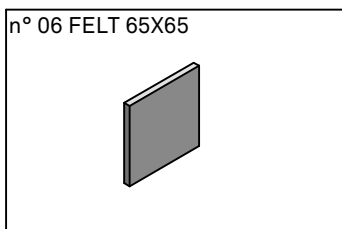
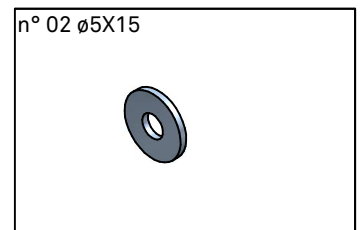
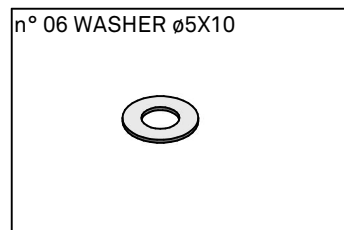
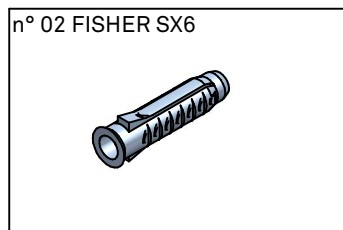
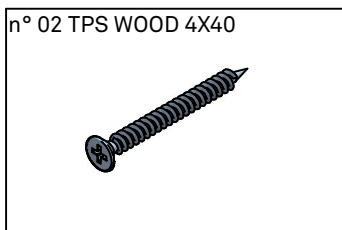
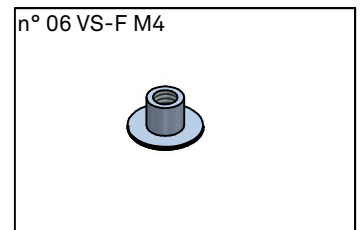
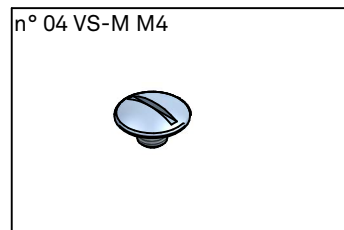
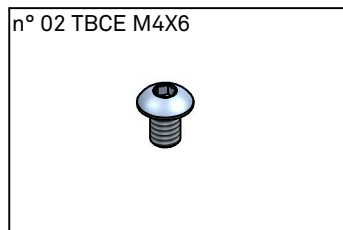



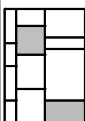
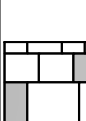
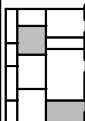
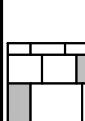
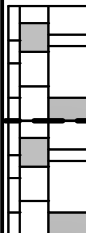
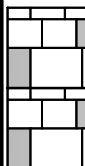













هام: ملف للتشاور في المستقبل.

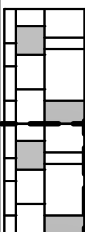
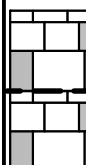
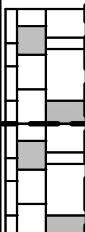
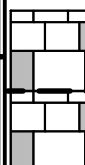

## HARDWARE



# CONFIGURAZIONI - CONFIGURATIONS

<p><b>Casi generali di configurazioni modulari: le seguenti indicazioni sono da considerare esempi relativi alle specifiche configurazioni.</b></p> <p><b>General cases of modular configurations: please take the following indications as example since they are related to these configurations specifically.</b></p>	1	1	2X1	2X1	1X2	1X2	
							
	parete di supporto posteriore back support wall						
	centro stanza room center					zavorra ballast	zavorra ballast
	parete di supporto laterale side support wall						
seguire pagine see pages 	5-9	5-9	5-8-9	5-8-9	5-6-7-9	5-6-7-9	
<p><b>Casi generali di configurazioni modulari: le seguenti indicazioni sono da considerare esempi relativi alle specifiche configurazioni.</b></p> <p><b>General cases of modular configurations: please take the following indications as example since they are related to these configurations specifically.</b></p>	2+1	2+1	2X2	2X2			
							
	parete di supporto posteriore back support wall						
	centro stanza room center	n° 02 zavorra n° 02 ballast	n° 02 zavorra n° 02 ballast	n° 02 zavorra n° 02 ballast	n° 02 zavorra n° 02 ballast		
	parete di supporto laterale side support wall	parete sinistra/zavorra left wall/ballast	parete sinistra/zavorra left wall/ballast	zavorra ballast	zavorra ballast		
seguire pagine see pages 	5-6-7-8-9	5-6-7-8-9	5-6-7-8-9	5-6-7-8-9			

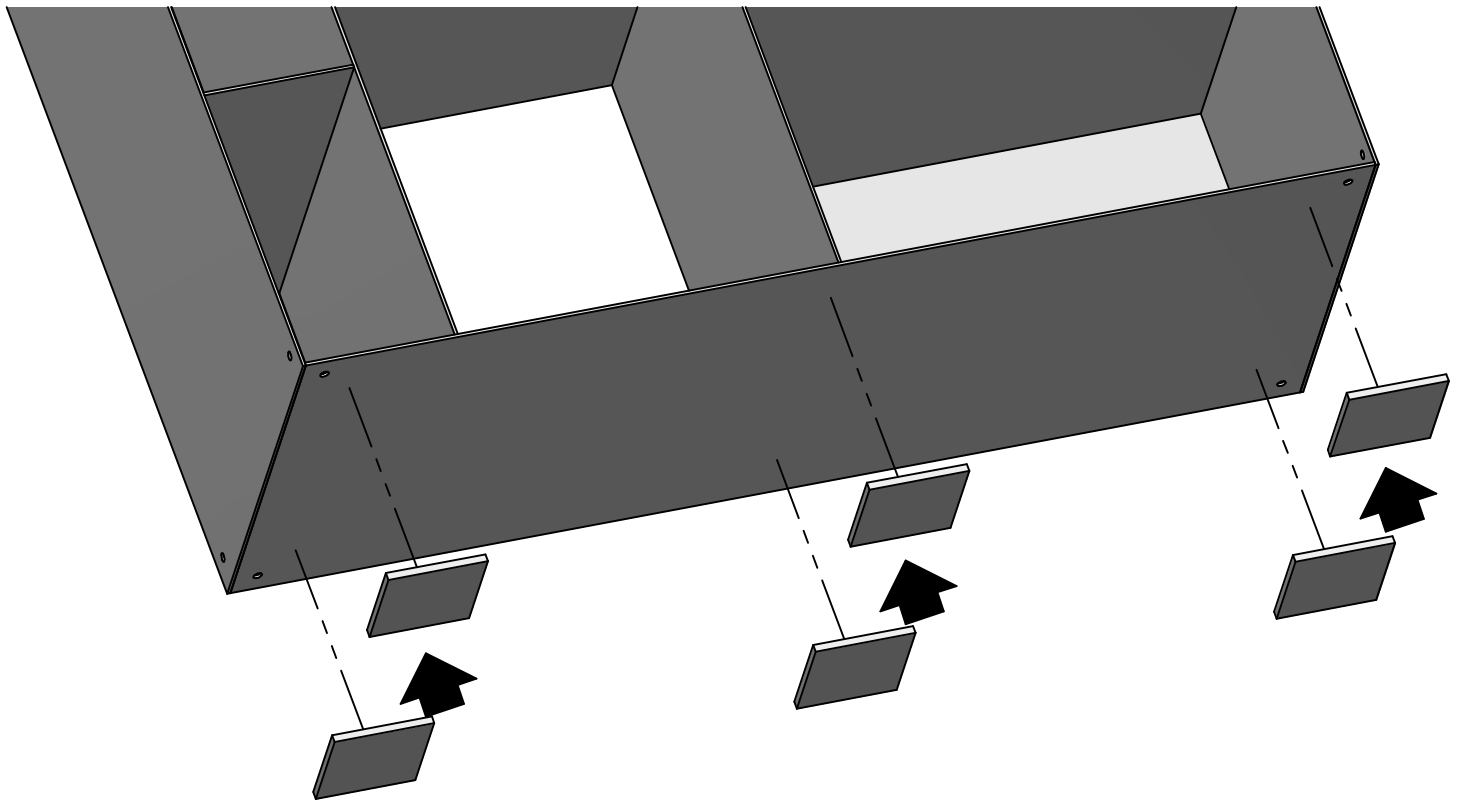
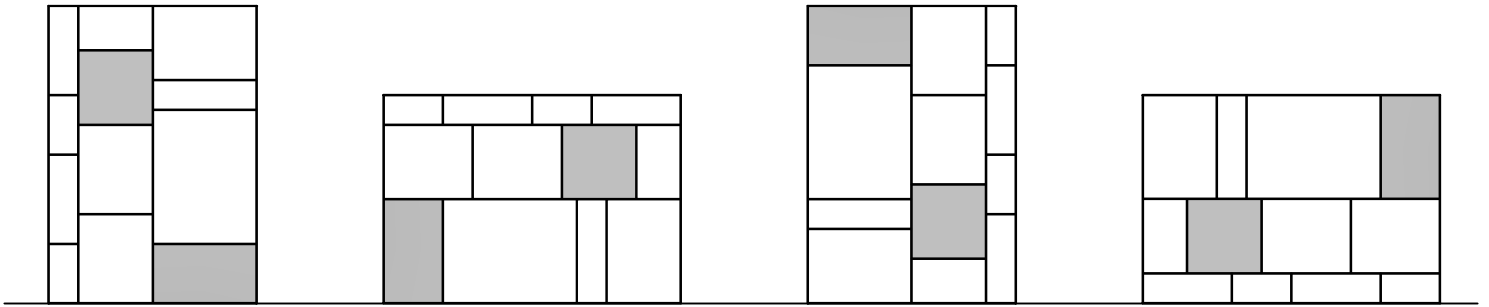
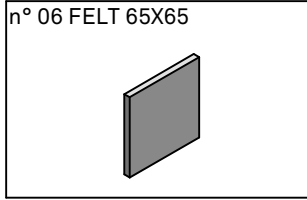

# FISSAGGIO VERTICALE - VERTICAL FIXING

n° 04 WASHER  $\phi$ 5X10



n° 04 VS-M M4



n° 04 VS-F M4



x2

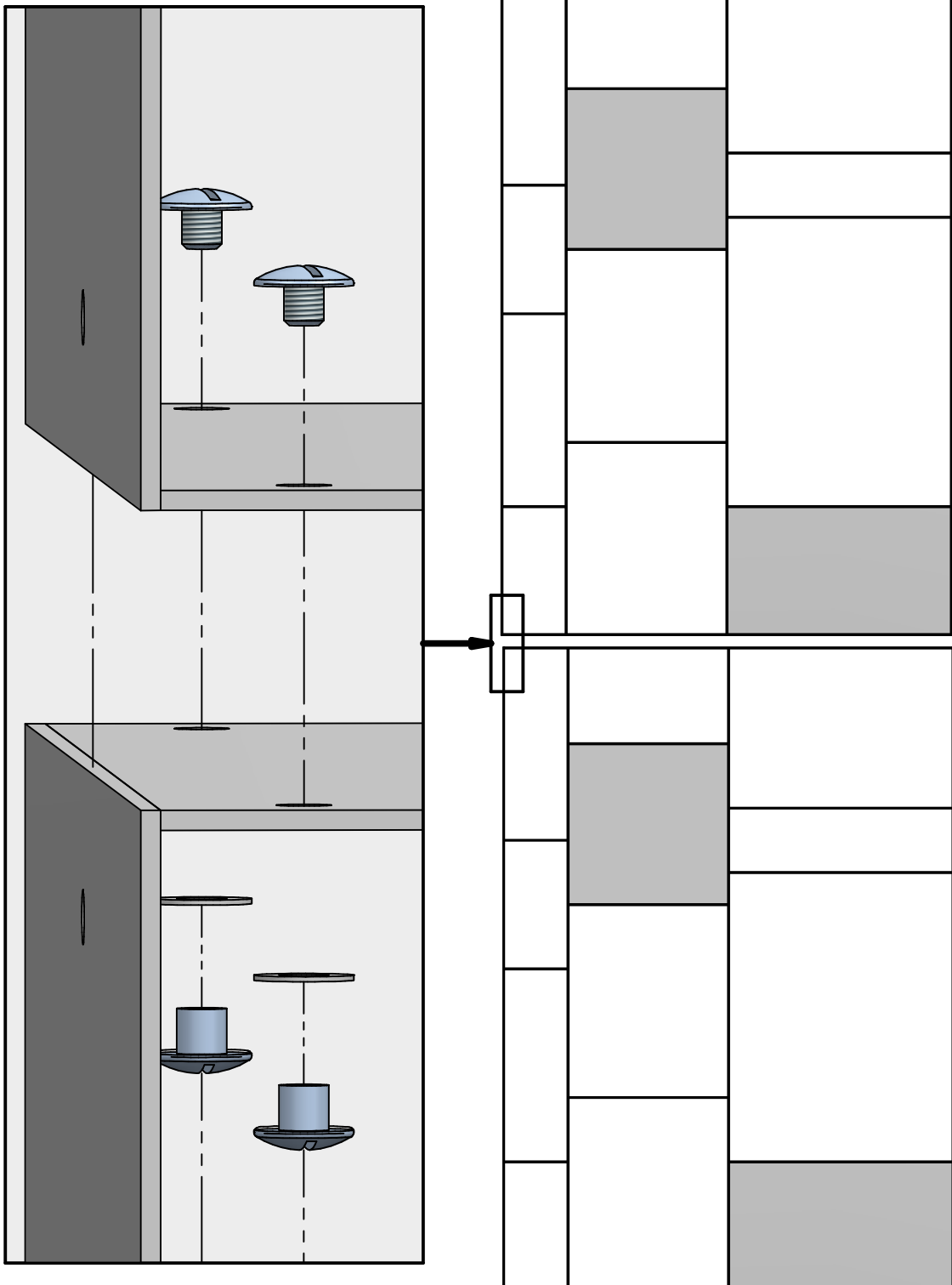

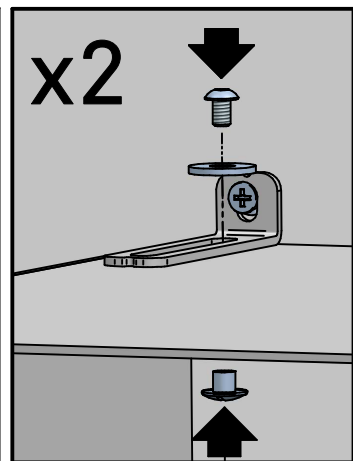
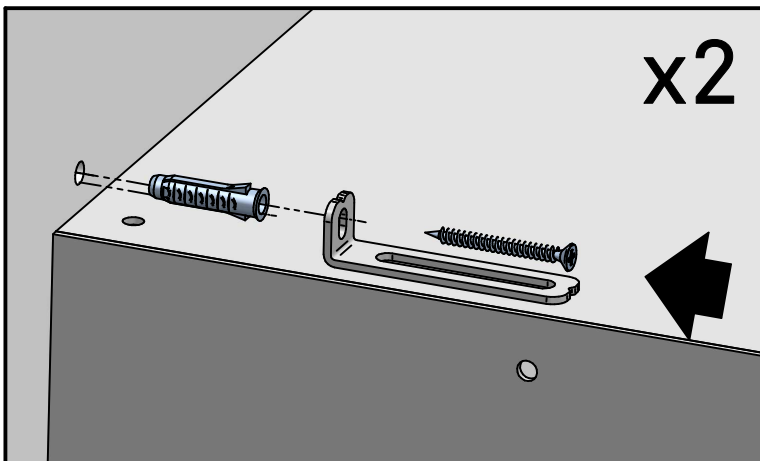
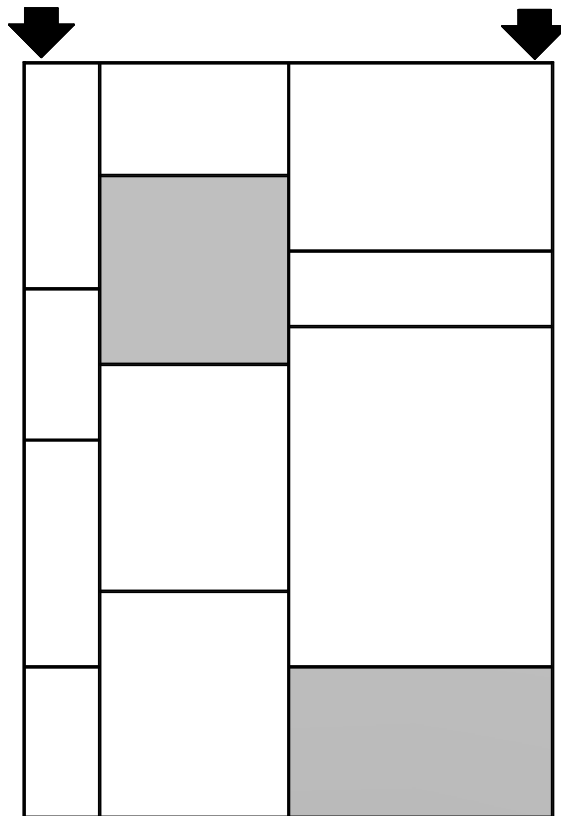
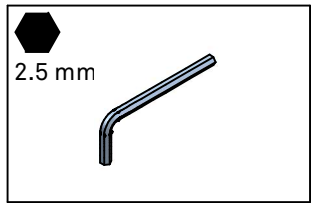
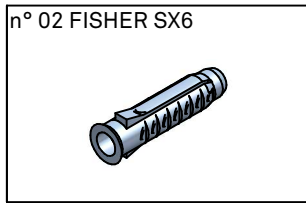
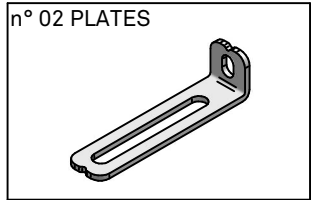
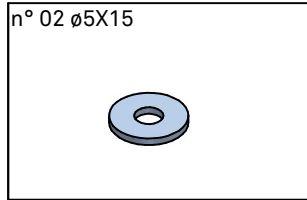
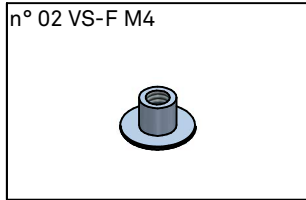

# FISSAGGIO LATERALE - SIDE FIXING

n° 04 VS-F M4



n° 04 VS-M M4



x2

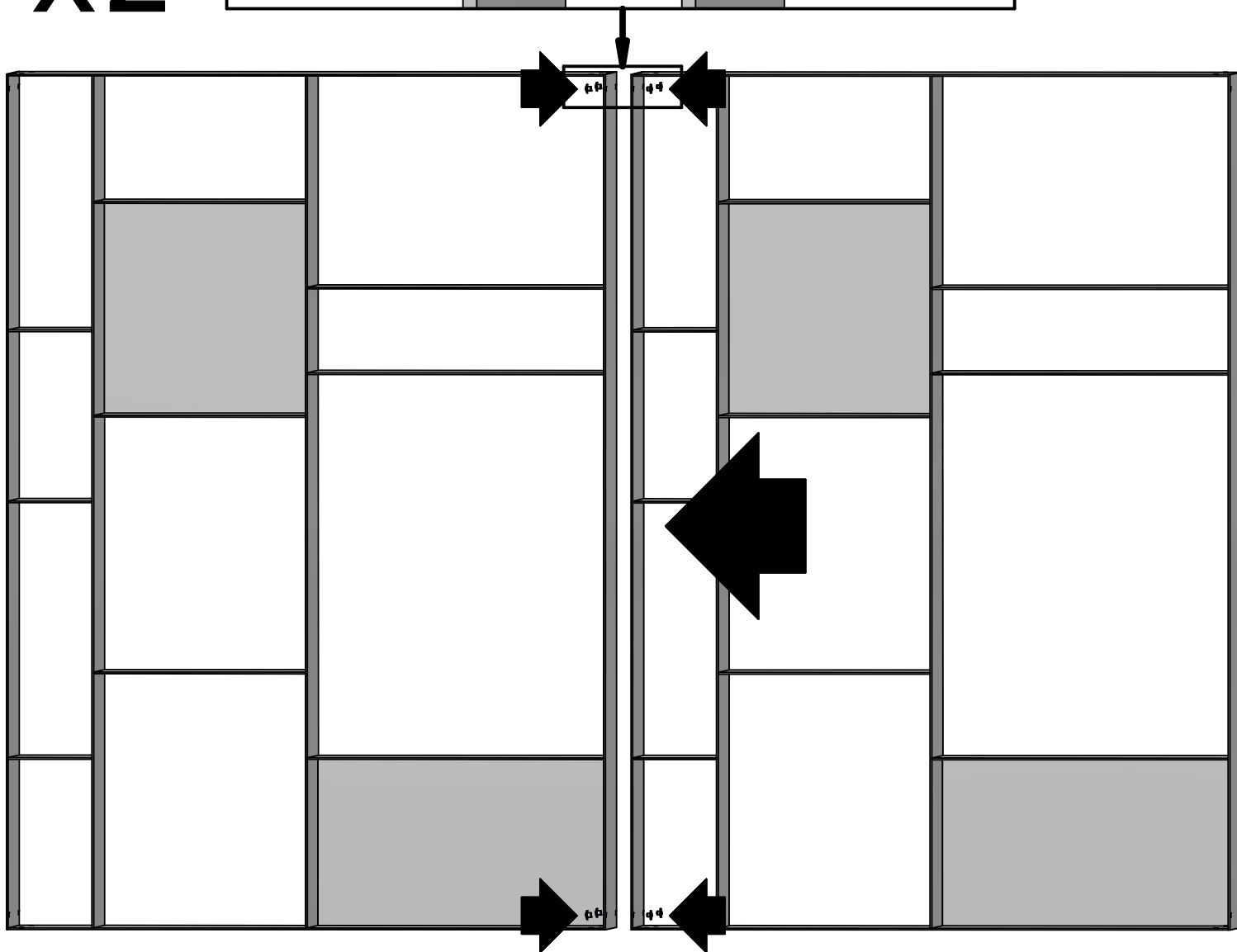
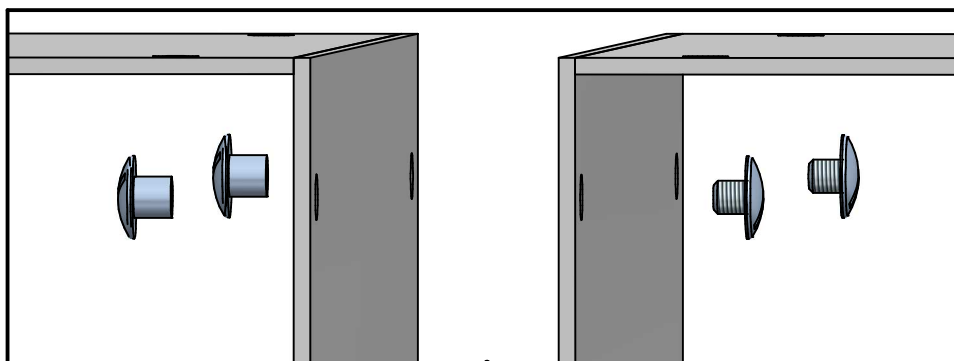



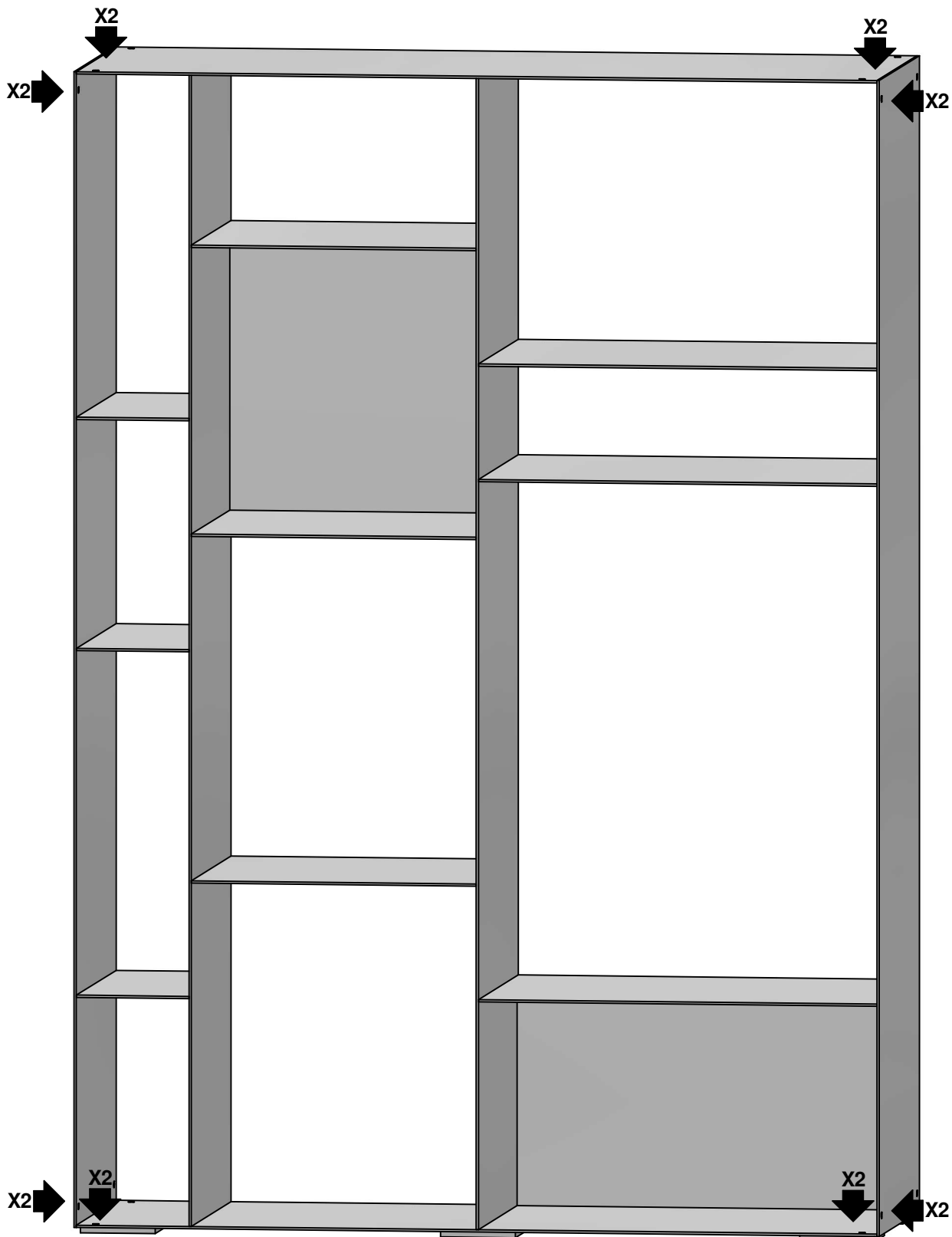
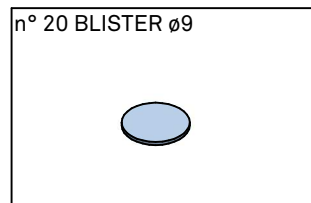

## **IT** USO

Il prodotto è destinato per l'utilizzo all'interno delle abitazioni con l'uso per il quale è stato realizzato.

### **SMALTIMENTO**

Una volta dismesso, il prodotto od i suoi componenti non vanno dispersi nell'ambiente ma conferiti ai sistemi pubblici di smaltimento.

### **MANUTENZIONE**

Non vanno assolutamente utilizzati strumenti metallici appuntiti o panni abrasivi per eliminare eventuali residui di sporco presenti sulla superficie del prodotto, in quanto possono danneggiare la superficie stessa. Non vanno assolutamente utilizzati detergenti che contengano cloro o a base di acido cloridrico, acido muriatico o prodotti anticalcare in quanto andrebbero ad alterare la brillantezza del prodotto.

### **PORTATA: 20 Kg MAX**

**Cattelan Italia spa si riserva di apportare, senza preavviso, modifiche nei materiali, nei rivestimenti, nelle finiture e nei disegni dei prodotti. Le texture ed i colori dei materiali e delle finiture hanno valore indicativo in quanto soggetti alle tolleranze dei processi di stampa.**

**IMPORTANTE: Riporre per eventuali consultazioni future.**

## **EN** USE

The product is intended for an indoor use and may only be used for its intended purpose.

### **DISPOSAL**

If your furniture is unusable or unrepairable, neither the product nor its components are to be dispersed in the environment, but rather consigned to public disposal systems.

### **MAINTENANCE**

It is recommended not to use metal sharp tools or abrasive clothes to eliminate dirt from the surface, because they could damage the same. Do not absolutely use detergents containing chlorine, muriatic acid, hydrochloric acid or descale detergents which can damage the surface brilliance.

### **WEIGHY CARRYING CAPACITY : 20 Kg MAX**

**Cattelan Italia spa reserves the right to change, without previous notice, materials, covers, finishes and drawings of the products. The textures and colours of materials and finishes are indicative as they are depending on the tolerances of the printing process.**

**IMPORTANT: File for future consultation.**

## **DE** NUTZUNG

Das Produkt ist nur für den Innenbereich gedacht. Der Tisch wurde hergestellt, nur als Esstisch genutzt zu werden.

### **ENTSORGUNG**

Nach der Aussonderung ist das Produkt und seine Bestandteile nicht selbständig im Freien zu entsorgen, sondern der städtischen Müllabfuhr zu übergeben.

### **WARTUNG**

Niemals scharfe Werkzeuge aus Metall, spitzen Instrumente oder Schleifmittel für die Reinigung der Oberfläche verwenden. Diese Produkte können die Oberfläche beschädigen. Niemals Chemikalien mit chlorhaltigen Salzsäure, Salzsäure oder Kalk-Produkte für die Reinigung verwenden. Diese Produkte können der Glanz beschädigen.

### **BELASTUNG: 20 Kg MAX**

**Cattelan Italia spa behaltet sich vor, ohne Vorankündigung, Veränderungen an den Materialien, Bezügen, Finish und Zeichnungen Produkte vorzunehmen. Die Texturen und Farben der Materialien und Finish haben einen hinweisenden Wert, da sie von den Toleranzen im Druckprozess abhängig sind.**

**WICHTIG: Bitte aufbewahren für eventuelle spätere Nachfragen.**

## **FR** UTILISATION

Le produit est destiné pour une utilisation à l'intérieur des habitations.

### **ECOULEMENT**

Une fois disloqué, le produit ou ses composants ne doivent pas être dispersés dans la nature mais confiés aux décharges publiques.

### **MANUTENTION**

Il ne faut pas absolument utiliser des outils pointus ou des chiffons abrasifs pour éliminer des possibles restes sur la surface du produit, parce qu'ils peuvent endommager la surface même. Ne pas utiliser des détergents contenant du chlore, acide chlorhydrique, acide muriatique ou produits anticalcare qui peuvent altérer le brillant du produit.

### **PORTEE: 20 Kg MAX**

**Cattelan Italia spa se réserve le droit d'apporter, sans préavis, des modification au niveau des matériaux, des revêtements, des finitions et du design des produits. Les textures et les couleurs des matériaux et des finitions sont une valeurs indicative parce-que ils changent selon la tolérance aux procédés d'imprimerie.**

**IMPORTANT: A conserver pour les futurs besoins de reference.**

**USO**

El producto está destinado para su uso dentro del hogar, a los fines por los cuales fue creado.

**ELIMINACIÓN DE DESECHOS**

Una vez desechado, el producto o sus componentes no se tienen que abandonar en el entorno sino entregar al sistema público de recogida de basuras.

**MANTENIMIENTO**

No utilizar en cualquier forma instrumentos de metal afilados o telas abrasivas para eliminar cualquier resto de suciedad en la superficie del producto, ya que pueden dañar la superficie misma. No utilizar en cualquier forma limpiadores a base de cloro o que contienen ácido clorhídrico, ácido muriático o productos anticalcáreos ya que pueden alterar el brillo del producto.

**PORTADA: 1x 7 Kg MAX**

**Cattelan Italia spa se reserva el derecho de aportar modificaciones de dibujo, materiales, acabados y tapicerías, sin que esté obligada a dar aviso anticipado. Las texturas y los colores de los materiales y de los acabados tienen solo un valor indicativo porque están sujetos a la tolerancia en los procesos de imprenta.**

**IMPORTANTE: Guardar para consultas posteriores.**

**ИСПОЛЬЗОВАНИЕ**

Изделие предназначено для использования внутри помещения.

**УТИЛИЗАЦИЯ**

После утилизации, продукт и его компоненты не должны разлагаться в окружающей среде, а должны быть переданы в специализированные места утилизации.

**УХОД**

Не используйте острые металлические инструменты или абразивные губки для удаления грязи, так как они могут повредить поверхности. Ни в коем случае не используйте моющие средства, содержащие хлор, соляную кислоту или средства от известкового налета, поскольку они могут повлиять на блеск предмета.

**Максимально допустимая нагрузка: 1x 7 Kg MAX**

**Cattelan Italia spa оставляет за собой право делать изменения, без предупреждения, в материалах, обивках, отделках и в чертежах продуктов, которые представлены в данном каталоге. Текстуры и цвета материалов и отделок в каталоге не передают реальные цвета предметов, из-за особенности процессов печати и цветопередачи. ВАЖНО: Сохранить для возможной будущей консультации.**

**使用:**

此产品仅限于室内使用，也只能按其用途使用。

**处理方法：**

如果家具不能使用或是不能修复，不要把产品及其部件散步在外面，应将其交由公共处置系统。

**保养:**

不建议使用锋利的金属工具或磨料织物去除表面上的污垢，因为它们可能会损害产品。请勿使用含有氟林，盐酸，氢氟酸的洗涤剂或浓缩洗涤剂清理产品，因为它们会破坏产品表面的光泽。

**承重力: 1x 7 Kg MAX****Cattelan Italia**

公司保留变更图册中材料、包覆材质、饰面、图像的权利，无须事先通知。因印刷等工艺存在偏差，材料和饰面等的纹理和颜色仅供参考。

重要事项：存档以备日后咨询

**cattelan  
italia**

**CATTELAN ITALIA SPA**  
Via Pilastri, 19  
36010 Carré (VI), Italy  
Ph. +39 0445 318711  
info@cattelanitalia.com  
www.cattelanitalia.com

